

GDS-2000

Digital Storage Oscilloscope

GDS-2062

GDS-2064

GDS-2102

GDS-2104

GDS-2202

GDS-2204

User Manual

Table of Contents

Safety Instructions	5
Safety Symbols	6
Safety Guidelines.....	6
Power cord for the United Kingdom	9
Getting Started	11
GDS-2000 characteristics.....	12
Package Contents	13
Power Up.....	14
Functionality check	15
Panel Descriptions	17
Front Panel	18
Rear Panel	21
Display.....	23
Quick Reference	25
Operation Shortcuts	26
Menu Tree	29
Default Settings	38
Configure the Settings	39
Acquisition.....	41
Cursor.....	45
Display.....	49
Horizontal View	54
Vertical	56
Other Settings.....	59
Battery Maintenance (Optional)	63

Measurements64

- Automatic Measurements.....65
- Go-No Go Test.....70
- Math Operation74
- Program and Play76
- Trigger78

Printout/ Data Transfer86

- Printout.....87
- Save/ Recall.....89

Remote Control97

- Use PC Software.....97
- Use IEEE based remote control 102

Calibration 114

- Calibrate the vertical scale 114
- Compensate the probe 115

FAQ 117

Appendix..... 119

- Specifications..... 119
- Declaration of Conformity 122

Index 123

Safety Instructions

This chapter contains important safety instructions that you must follow when operating GDS-2000 and when keeping it in storage. Read the following before any operation to insure your safety and to keep the best condition for GDS-2000.

Safety Symbols	Safety Symbols	6
Safety Guidelines	General Guideline	6
	Power Supply	7
	Fuse	7
	Cleaning GDS-2000	7
	Operation Environment.....	8
	Storage Environment	8
Power Up	Power cord for the United Kingdom	9

Safety Symbols

These safety symbols may appear in this manual or on GDS-2000.



WARNING

Warning: Identifies conditions or practices that could result in injury or loss of life.



CAUTION

Caution: Identifies conditions or practices that could result in damage to GDS-2000 or to other properties.



DANGER High Voltage



Attention Refer to Manual



Protective Conductor Terminal



Earth (ground) Terminal

Safety Guidelines

General Guideline

- Make sure the BNC input voltage does not exceed 300V_{peak}.



CAUTION

- Never connect a hazardous live voltage to the ground side of the BNC connectors. It might lead to fire and electrical shock.
- Do not place any heavy object on GDS-2000.
- Avoid severe impacts or rough handling that leads to damaging GDS-2000.
- Do not discharge static electricity to GDS-2000.
- Use only mating connectors, not bare wires, for the terminals.
- Do not block or obstruct cooling fan vent

opening.

- Do not perform measurements at power source and building installation site (Note below).
- Do not disassemble GDS-2000 unless you are qualified as service personnel.

(Note) EN 61010-1:2001 specifies the measurement categories and their requirements as follows. GDS-2000 falls under category II. Measurement category IV is for measurement performed at the source of low-voltage installation.

Measurement category III is for measurement performed in the building installation.

Measurement category II is for measurement performed on the circuits directly connected to the low voltage installation.

Power Supply



WARNING

- Input voltage: 100 ~ 240 V AC, 48 ~ 63Hz
 - The power supply voltage should not fluctuate more than 10%.
 - Connect the protective grounding conductor of the power cord to earth ground, to avoid electrical shock.
-

Fuse



WARNING

- Fuse type: T2A/ 250V
 - Make sure the correct type of fuse is installed before powering up.
 - Replace the fuse with the specified type and rating only, for continued fire protection.
 - Disconnect the power cord before fuse replacement.
 - Make sure the cause of the fuse blowout is fixed before fuse replacement.
-

Cleaning GDS-2000

- Disconnect the power cord before cleaning.
- Use a soft cloth dampened in a solution of mild detergent and water. Do not spray any liquid

into GDS-2000.

- Do not use chemicals or cleaners containing harsh materials such as benzene, toluene, xylene, and acetone.

Operation Environment

Location: Indoor, no direct sunlight, dust free, almost non-conductive pollution (Note below)

Relative Humidity: < 80%

Altitude: < 2000m

Temperature: 0°C to 50°C

(Note) EN 61010-1:2001 specifies the pollution degrees and their requirements as follows.

GDS-2000 falls under degree 2.

Pollution refers to “addition of foreign matter, solid, liquid, or gaseous (ionized gases), that may produce a reduction of dielectric strength or surface resistivity”.

Pollution degree 1: No pollution or only dry, non-conductive pollution occurs. The pollution has no influence.

Pollution degree 2: Normally only non-conductive pollution occurs. Occasionally, however, a temporary conductivity caused by condensation must be expected.

Pollution degree 3: Conductive pollution occurs, or dry, non-conductive pollution occurs which becomes conductive due to condensation which is expected. In such conditions, equipment is normally protected against exposure to direct sunlight, precipitation, and full wind pressure, but neither temperature nor humidity is controlled.

Storage Environment

Location: Indoor

Relative Humidity: < 80%

Temperature: 0°C to 50°C

Power cord for the United Kingdom

When using GDS-2000 in the United Kingdom, make sure the power cord meets the following safety instructions.

NOTE: This lead / appliance must only be wired by competent persons



WARNING: THIS APPLIANCE MUST BE EARTHED

IMPORTANT: The wires in this lead are coloured in accordance with the following code:

Green/ Yellow: Earth
Blue: Neutral
Brown: Live (Phase)



As the colours of the wires in main leads may not correspond with the colours marking identified in your plug/appliance, proceed as follows:

The wire which is coloured Green & Yellow must be connected to the Earth terminal marked with the letter E or by the earth symbol  or coloured Green or Green & Yellow.

The wire which is coloured Blue must be connected to the terminal which is marked with the letter N or coloured Blue or Black.

The wire which is coloured Brown must be connected to the terminal marked with the letter L or P or coloured Brown or Red.

If in doubt, consult the instructions provided with the equipment or contact the supplier.

This cable/appliance should be protected by a suitably rated and approved HBC mains fuse: refer to the rating information on the equipment and/or user instructions for details. As a guide, cable of 0.75mm² should be protected by a 3A or 5A fuse. Larger conductors would normally require 13A types, depending on the connection method used.

Any moulded mains connector that requires removal /replacement must be destroyed by removal of any fuse & fuse carrier and disposed of immediately, as a plug with bared wires is hazardous if a engaged in live socket. Any re-wiring must be carried out in accordance with the information detailed on this label.

Getting Started

Follow these instructions to properly setup GDS-2000, especially if you are using it for the first time.

GDS-2000 Characteristics	Main Features	12
Package Contents	Opening the box	13
	Contents	13
Power Up	Tilt stand	14
	Turn on the Main Power	14
	Press the ON/ Standby key	14
	Display view	14
Functionality Check	1. Connect the Probe.....	15
	2. Capture the signal.....	15
	3. Set the scale	16
	4. Compensate the probe.....	16
	5. Start Measurements	16

GDS-2000 characteristics

GDS-2000 is a generic purpose digital storage oscilloscope suitable for wide range of applications such as production testing, research, and field verification.

Main Features

- Wide selection range: 60MHz to 200MHz bandwidth, 2 or 4 channels
 - High Sampling rate: up to 1 GS/s real-time, 25GS/s equivalent-time
 - Powerful display: 5.6 in. color TFT, wide viewing angle, 8 x 12 divisions waveform support
 - USB connection: to printers and storage devices
 - DC Power (battery) operation
 - Deep memory: 25k points record length
 - Automatic measurements: maximum 24 types
 - Peak detection: up to 10ns
 - FFT analysis
 - Triggers: Video, Pulse width, Average, Delay
 - Program and play mode
 - Go-No Go test
 - Built-in help
 - PC software control & IEEE based remote access
-

Package Contents

Check the contents before using GDS-2000. Contact your local dealer in case there is a missing item.

Opening the box

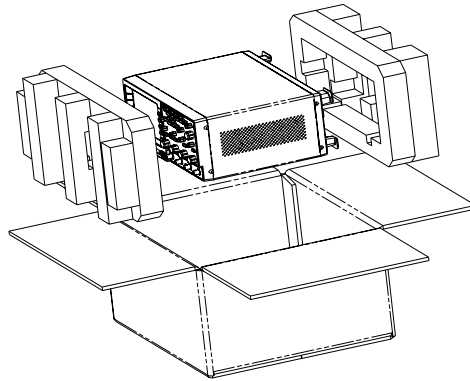

Contents

1. Main unit

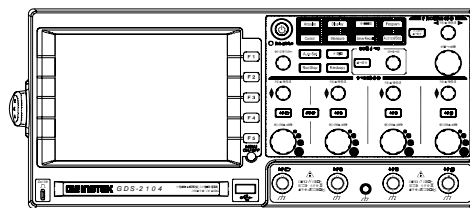

2. Probe set

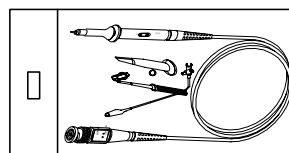

GDS-2062: GTP060A x 2
GDS-2064: GTP060A x 4
GDS-2102: GTP150A x 2
GDS-2104: GTP150A x 4
GDS-2202: GTP250A x 2
GDS-2204: GTP250A x 4

3. Power cord

4. User manual (this document)

Power Up

Place and power up GDS-2000 as follows.

Tilt stand

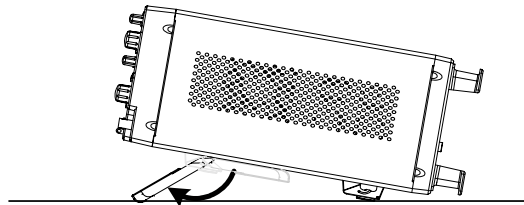

Turn on the Main Power

1. Connect the Power Cord to the rear panel.
2. Turn ON the Main Power Switch.
3. The ON/STBY indicator on the front panel turns red.

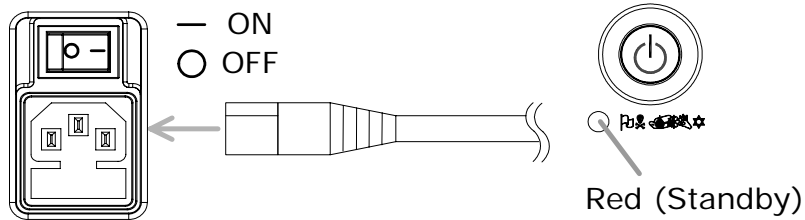

Press the ON/Standby key

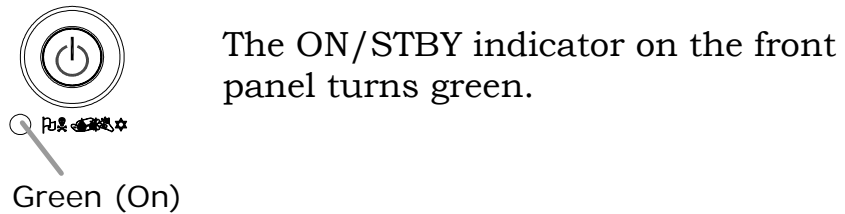

Display view

The display becomes active in 15~20 seconds.

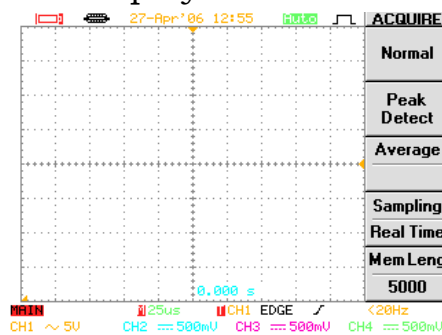

From the second time, the last display setting appears.

Functionality check

Before operating GDS-2000 in a new environment, run these steps to make sure it is functionally stable.

1. Connect the Probe

Connect the probe to Channel1 input terminal and to the probe calibration output (2Vpp±3%, 1kHz square wave).
Set the probe attenuation scale to x10.

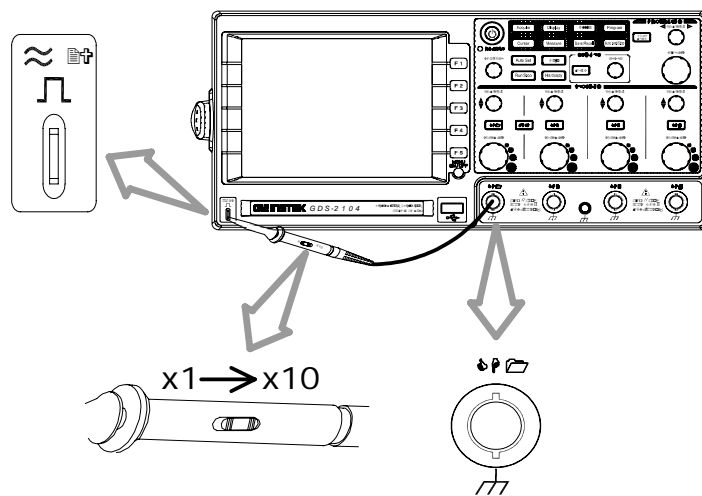

2. Capture the signal

Make sure the compensation signal appears. If CH1 is inactive (CH1 key LED is Off), press CH1 key and activate it (LED On).

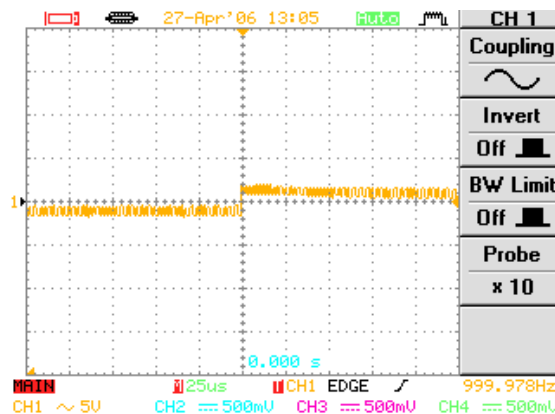

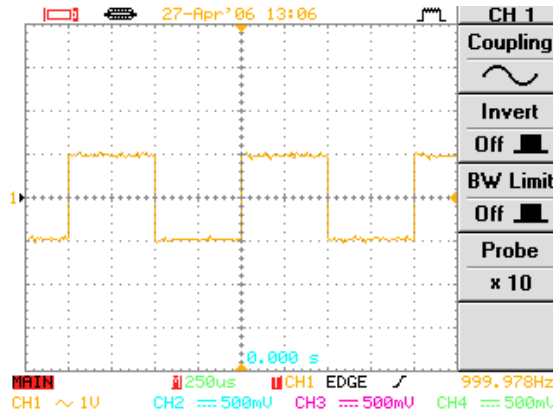

3. Set the scale

Press Auto Set key . GDS-2000 automatically adjusts the horizontal scale, vertical scale, and trigger level. For Auto Set details, see page65.



Probe compensation signal, 2Vpp, 1kHz

4. Compensate the probe

Watch the reference signal edge and compensate the probe accordingly. To adjust the scale, use Volts/Div knob  (Vertical) and Time/Div knob  (horizontal). For more details, see page115.

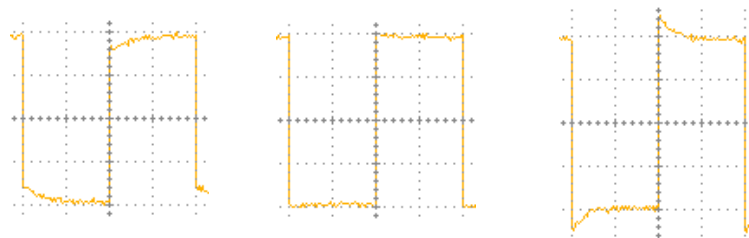

Over Compensation

Normal

Under Compensation

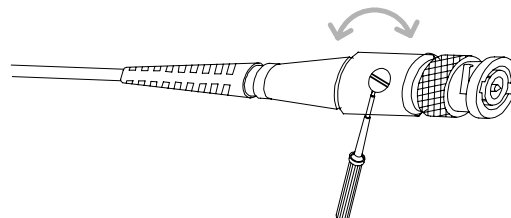

5. Start Measurements

Continue with the other measurements. For shortcuts to major operations, see page26. Detailed description starts from page39.

Panel Descriptions

Front Panel	GDS-2064/ 2104/ 2204 front panel	18
	GDS-2062/ 2102/ 2202 front panel	18
	Description of front panel items	19
Rear Panel	GDS-2062/ 2064/ 2102/ 2104/ 2202/ 2204 rear panel.....	21
	Description of rear panel items	22
Display	GDS-2062/ 2064/ 2102/ 2104/ 2202/ 2204 display	23
	Description of display items	23

Front Panel

GDS-2064/ 2104/ 2204 front panel

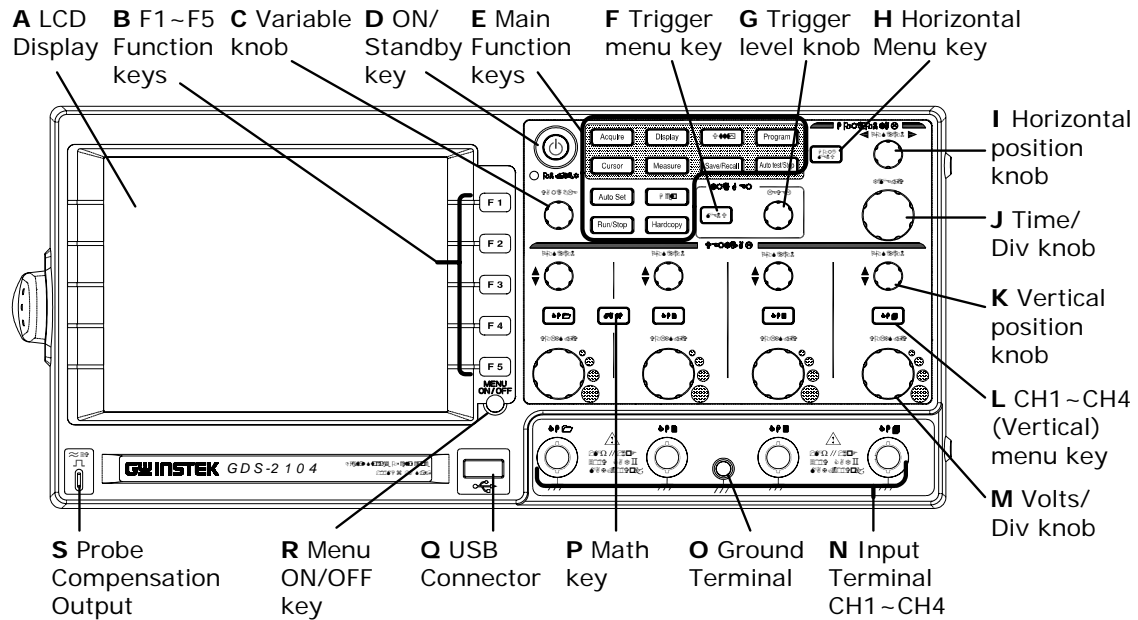

GDS-2062/ 2102/ 2202 front panel

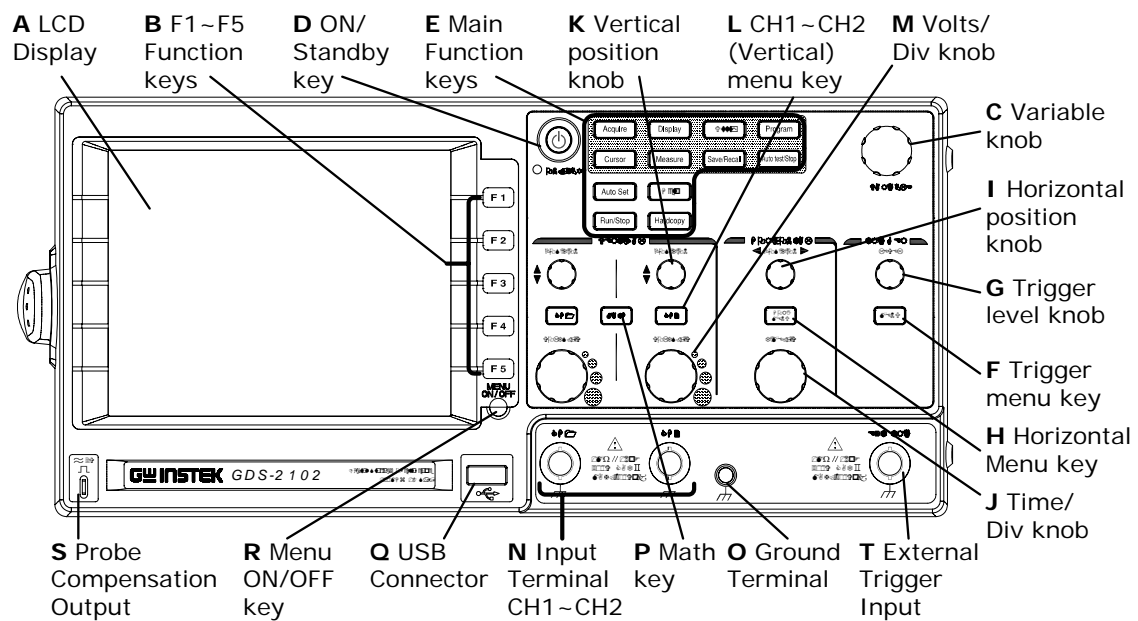

 Description of front panel items

- | | | |
|---|-------------------------|--|
| A | LCD Display | TFT Color, 320x234 resolution LCD display. |
| B | F1 ~F5
Function Keys | Soft keys linked to functions shown on the left side of the display. |
| C | Variable knob | Clockwise: increases the value or move to the next parameter.
Counterclockwise: decreases the value or go back to the previous parameter. |
| D | On/Standby
key | Press once: Power On (green indicator).
Press again: Standby (red indicator). |
| E | Main Function
keys | <p>Acquire key is for configuring acquisition mode. See page41.</p> <p>Display key is for configuring display settings. See page49.</p> <p>Utility key is for configuring system settings (page59), running Go-No Go test (page70), printout and data transfer together with Hardcopy key (page86), and calibration (page114).</p> <p>Program key, together with Auto test/Stop key, are for Program and Play. See page76.</p> <p>Cursor key is for configuring horizontal and vertical cursors. See page45.</p> <p>Measure key is for configuring and running automatic measurements. See page66.</p> <p>Help key is for displaying help contents on the display. See page59.</p> <p>Save/Recall key is for saving and recalling image, waveform, and settings between USB and internal memory. See page89.</p> <p>Auto Set key is for finding signals and setting scales automatically. See page65.</p> <p>Run/Stop key is for freezing the signal view(Stop). See page51.</p> |
| F | Trigger menu
key | For configuring the trigger settings. See page78. |
| G | Trigger level | Sets the trigger level: increase (clockwise) or |

	knob	decrease (counterclockwise).
H	Horizontal menu key	For configuring the horizontal view. See page54.
I	Horizontal position knob	Moves the waveform right (clockwise) or left (counterclockwise).
J	Time/Div knob	For setting the horizontal scale: fine (clockwise) or coarse (counterclockwise).
K	Vertical position knob	Moves the waveform upward (clockwise) or downward (counterclockwise).
L	Channel (Vertical) menu key	For configuring the vertical view for each channel. See page56.
M	Volts/Div knob	For setting the vertical scale for each channel: fine (clockwise) or coarse (counterclockwise).
N	Input Terminal	BNC male connector for signal input.
O	Ground Terminal	Terminal for connecting the DUT (Device Under Test) ground lead.
P	Math key	For performing Math operations using Channel 1 and 2 input signals. See page74.
Q	USB connector	Type A host female, 1.1/ 2.0 compatible. For printing (page87) and data transfer (page89).
R	Menu On/Off key	Show (On) or hide (Off) the menu from the display. See page53.
S	Probe compensation Output	2Vpp signal output for probe compensation. See page115.
T	External Trigger Input	(2CH model only) For external trigger signal used in advanced delay triggering. See page83.

Rear Panel

GDS-2062/ 2064/ 2102/ 2104/ 2202/ 2204 rear panel

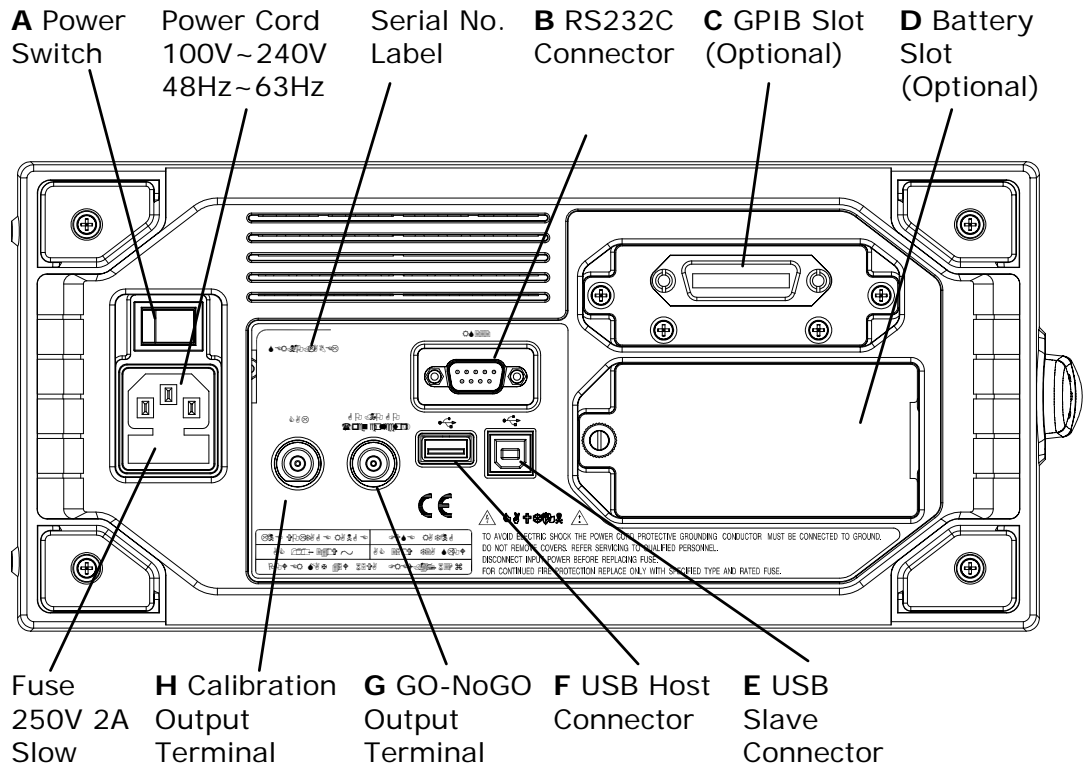

Description of rear panel items

A Power Switch	—: ON (front panel indicator turns green) ○: OFF (front panel indicator turns red) For power up sequence, see page14.
B RS232C Connector	9 pin male connector used for IEEE based remote control. See page102.
C GPIB Slot (Optional)	24 pin female connector used for IEEE based remote control. See page102.
D Battery Slot (Optional)	10.8V Li-Ion battery pack, 12h charging time/ 3h operation time. See page63.
E USB Slave Connector	Type B slave female connector used for PC software connection (page97) and IEEE based remote control (page102).
F USB Host Connector	Type A host female, 1.1/2.0 compatible. Has the same functionality as the front panel USB connector. (NOT allowed to use them both at the same time)
G Go-NoGo Output Terminal	Outputs Go-NoGo test result as a pulse signal. See page70.
H Calibration Output Terminal	Outputs signal used in calibrating GDS-2000. See page114.

Display

GDS-2062/ 2064/ 2102/ 2104/ 2202/ 2204 display

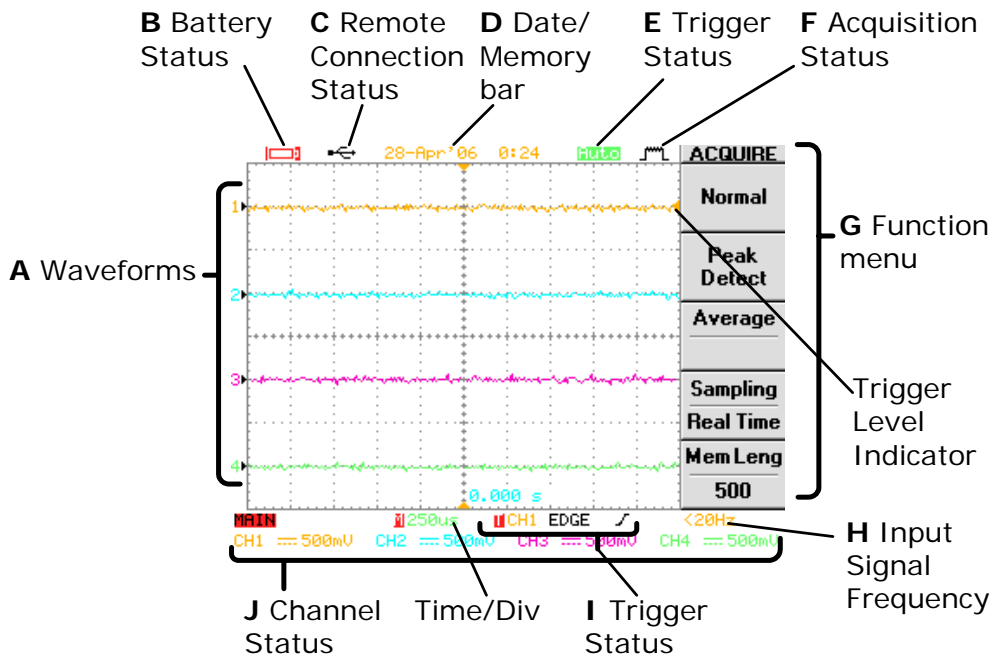

Description of display items

- | | |
|------------------------------------|--|
| A Waveforms | Input signal waveforms, activated by pressing the Channel key.

Channel1: Amber Channel2: Blue
Channel3: Pink Channel4: Green |
| B Battery Status (Optional) | Indicates the remaining battery level, when the battery is installed. |
| C Remote Connection Status | The active interface for PC software/ Remote control.
<ul style="list-style-type: none"> ☐: RS232C is active ☐: USB is active ☐: GPIB (optional) is active |
| D Date/ Memory bar | 28-Apr'06 0:24 : (Default) The current time and date, configured in the Utility menu. See page61. |

- E Trigger Status**

 The memory bar temporary appears when configuring the horizontal scale (page54), memory length (page43), and zoom (page54), indicating the ratio and the position of display waveform compared with the internally stored information.

Auto: Trigger level is automatically adjusted

None: Trigger condition is not found

STOP: Triggering is halted

For triggering details, see page78.
 - F Acquisition Status**

 Normal mode

 Peak Hold mode

 Average mode

For acquisition details, see page41.
 - G Function key**

The active function key and menu corresponding to F1~F5 soft keys.
 - H Input Signal Frequency**

The signal frequency of the selected channel.

<20Hz shows the frequency is less than 20Hz.
 - I Trigger Status**

CH1 EDGE 

(From left) Trigger source channel, trigger type, and slope

For trigger details, see page78.
 - J Channel Status**

CH1 500mV

(From left) Channel, Bandwidth limit, Coupling mode, Time/Div scale

For Channel (vertical scale) details, see page56.
-

Quick Reference

Operation	Configure the System.....	26
Shortcuts	Measure the Signal	27
	Print and Data Transfer.....	27
	Remote Control	28
	Calibration	28
Menu Tree	Acquire, Channel, Cursor, Display.....	29
	Horizontal, Math, Measure (1 of 2)	30
	Measure (2 of 2), Program	31
	Save/ Recall (1 of 2)	32
	Save/ Recall (2 of 2)	33
	Trigger	34
	Utility (1 of 3)	35
	Utility (2 of 3)	36
	Utility (3 of 3)	37
Default Settings	Default Settings	38

Operation Shortcuts

Here is the list of operations introduced in this manual and their key shortcuts.

Symbols description

Display→F1	=Press the Display key, then press F1
F1↵	=Press F1 repeatedly, if necessary
F1~F4	=Use all F1, F2, F3, and F4 to complete the operation

Configure the System

Acquisition

Select the Acquisition mode	Acquire→F1~F4
Select the memory length	Acquire→F5

Cursor

Select the horizontal cursor	Cursor→F1~F2
Select the vertical cursor	Cursor→F1, F3

Display

Freeze the waveform	Run/Stop
Refresh the display view	Display→F3
Select the display grid	Display→F5
Select the vectors/dots waveform	Display→F1
Set the display contrast	Display→F4
Turn Off the display menu	Menu ON/OFF
View accumulated waveform	Display→F2

Horizontal

Zoom the horizontal view	HORIMENU→F2~F3
Roll the horizontal view	HORIMENU→F4
View in XY mode	HORIMENU→F5

Vertical

Invert the waveform	CH1/2/3/4→F2
Limit the frequency bandwidth	CH1/2/3/4→F3
Select the coupling mode	CH1/2/3/4→F1
Select the probe attenuation	CH1/2/3/4→F4

Other Configurations

Select the buzzer sound	Utility→F3
-------------------------	------------

Select the language	Utility→F4
Set the date/time	Utility→F5→F5→F2→F1↵
View the system information	Utility→F5→F2

Measure the Signal

Automatic Measurements

Delay automatic measurements	Measure→F5→F3↵
Set the scale automatically	Auto Set
Time automatic measurements	Measure→F3→F3↵
View all the measurement results	Measure→Measure→F1~F4
Voltage automatic measurements	Measure→F1→F3↵

Go-No Go Test

Edit Go-No Go test template	Utility→F3→F2~F3 Utility→F3→F1→F1~F4 Utility→F5→F4
Run Go-No Go test	Utility→F5→F3→F4

Math Operation

Add/ Subtract/ Multiply/ Divide	MATH→F1↵→F2~F4
Run FFT operation	MATH→F1↵→F2~F5

Program and Play

Edit the program steps	Program→F1↵→F2~F5
Play the program	Program→F1↵→F2~F5

Trigger

Use Delay trigger	Trigger→F1↵→F2~F4→F5→ F1~F4
Use Edge trigger	Trigger→F1↵→F2~F3→F5→ F1~F4
Use Pulse width trigger	Trigger→F1↵→F2~F4→F5→ F1~F4
Use Video trigger	Trigger→F1↵→F2~F5

Print and Data Transfer

Printout

Printout display image/waveform	Utility→F1↵→F1 Hardcopy
---------------------------------	----------------------------

Save and Recall

Quick save to USB	Utility→F1→F1 Hardcopy
Save all (image/setup/waveform)	Save/Recall→F5→F2→F1~F4
Save image	Save/Recall→F5→F1→F1~F4

Save setup	Save/Recall→F3→F1~F4
Save waveform	Save/Recall→F4→F1~F4
Recall setup	Save/Recall→F5→F3→F1~F4
Recall waveform	Save/Recall→F5→F4→F1~F4
Configure folders in USB memory	Save/Recall→F3→F5→F1~F4

Remote Control

Configure the interface	Utility→F2→F1↵
-------------------------	----------------

Calibration

Calibrate GDS-2000	Utility→F5→F1→F1~F3
Compensate the probe	Utility→F5→F5→F1→F1~F3

Menu Tree

No menu for the following keys: Auto Set, Run/Stop, Help, Auto test/Stop, Hardcopy.

Acquire, Channel, Cursor, Display

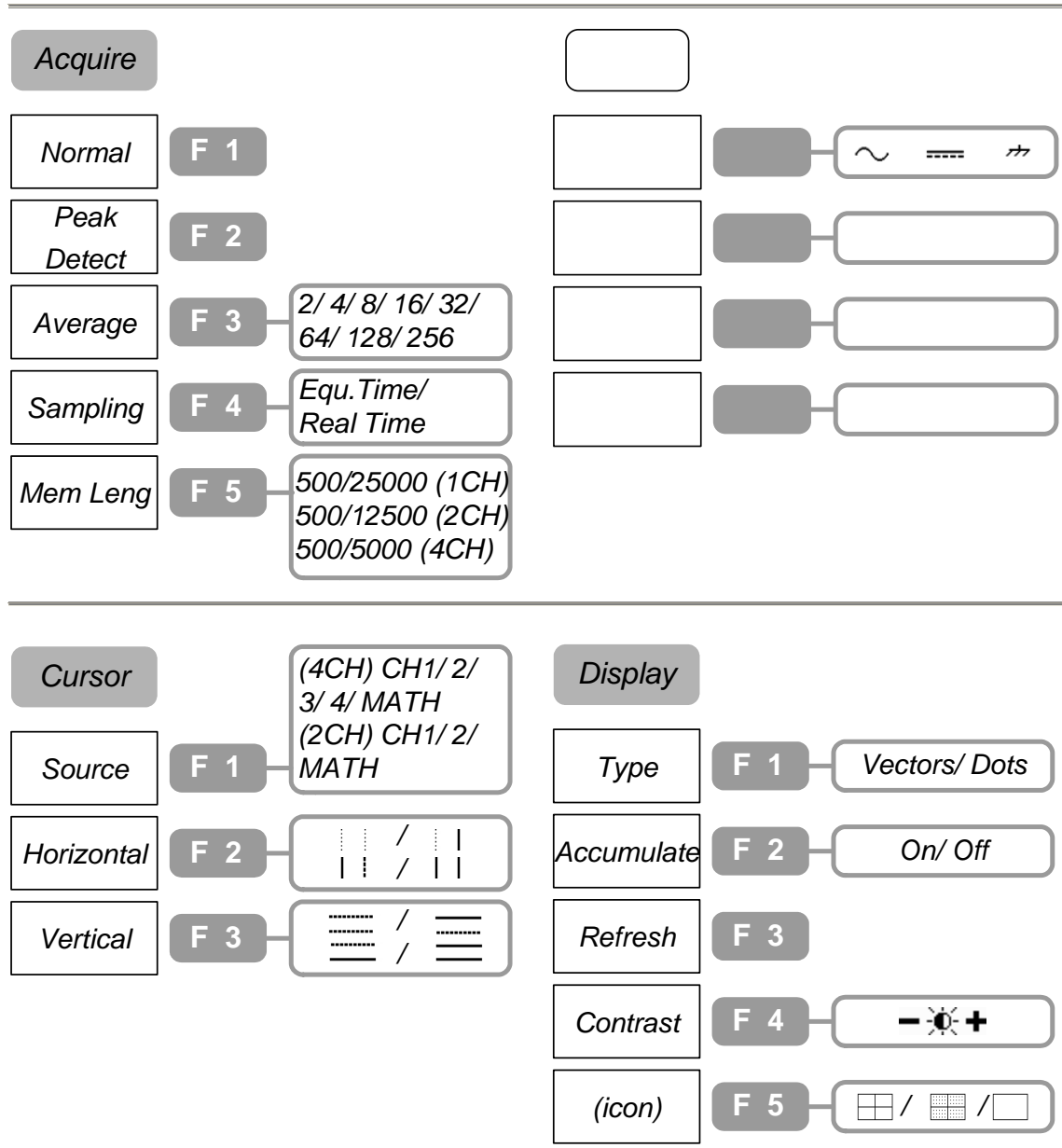

Horizontal, Math, Measure (1 of 2)

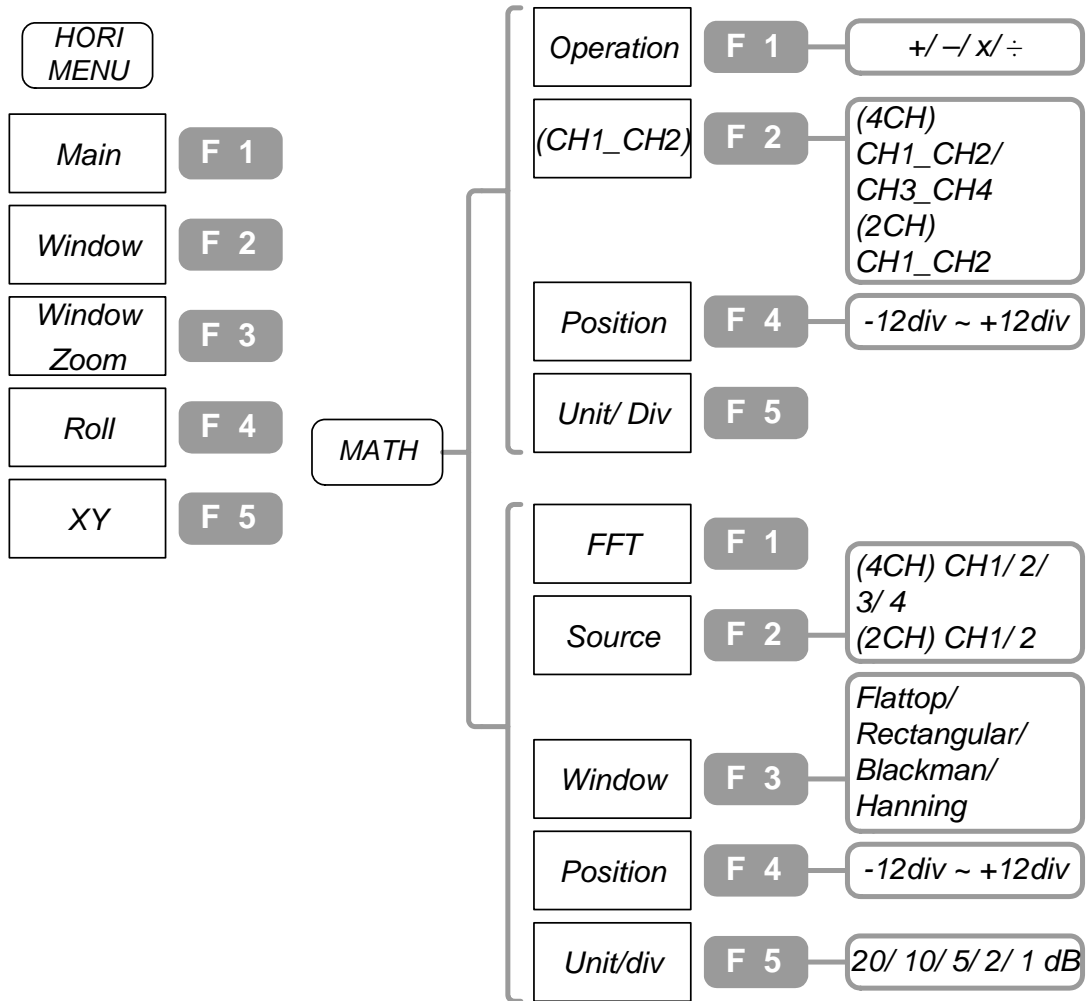

(Press once)

(Press twice)

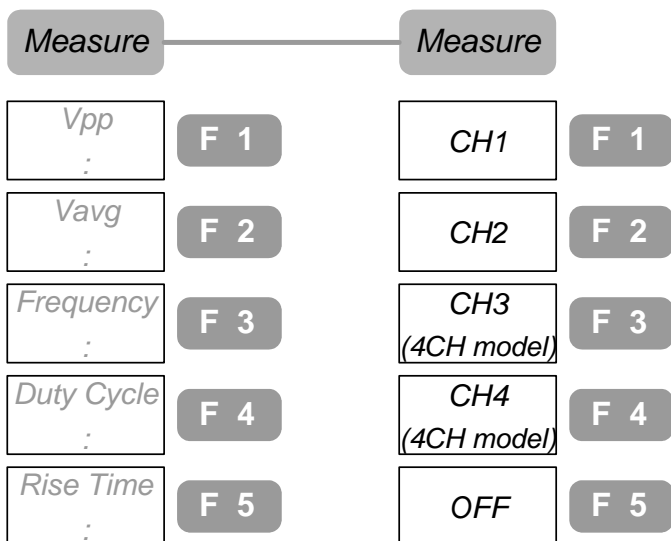

Measure (2 of 2), Program

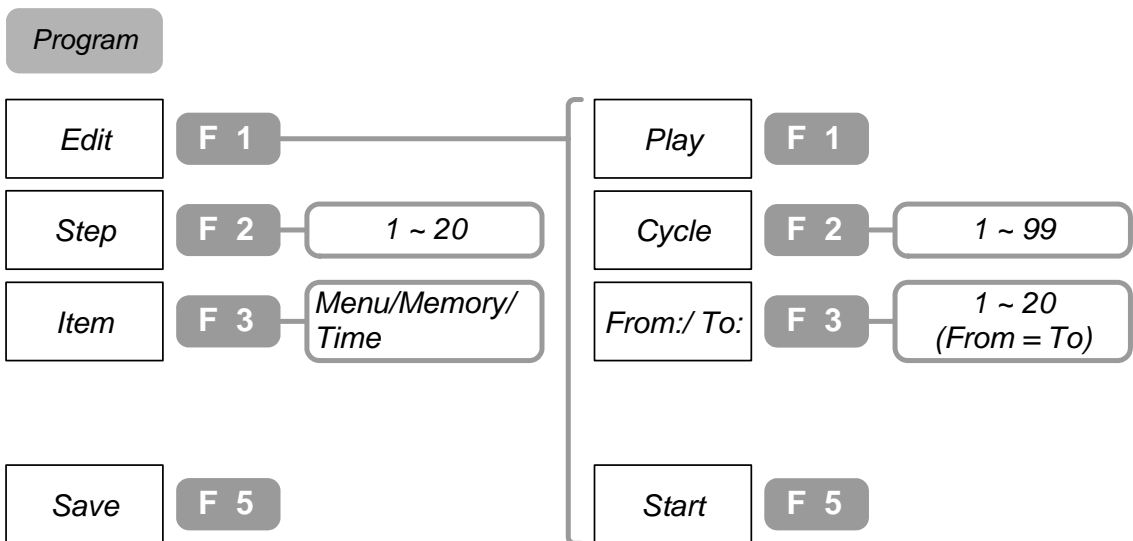
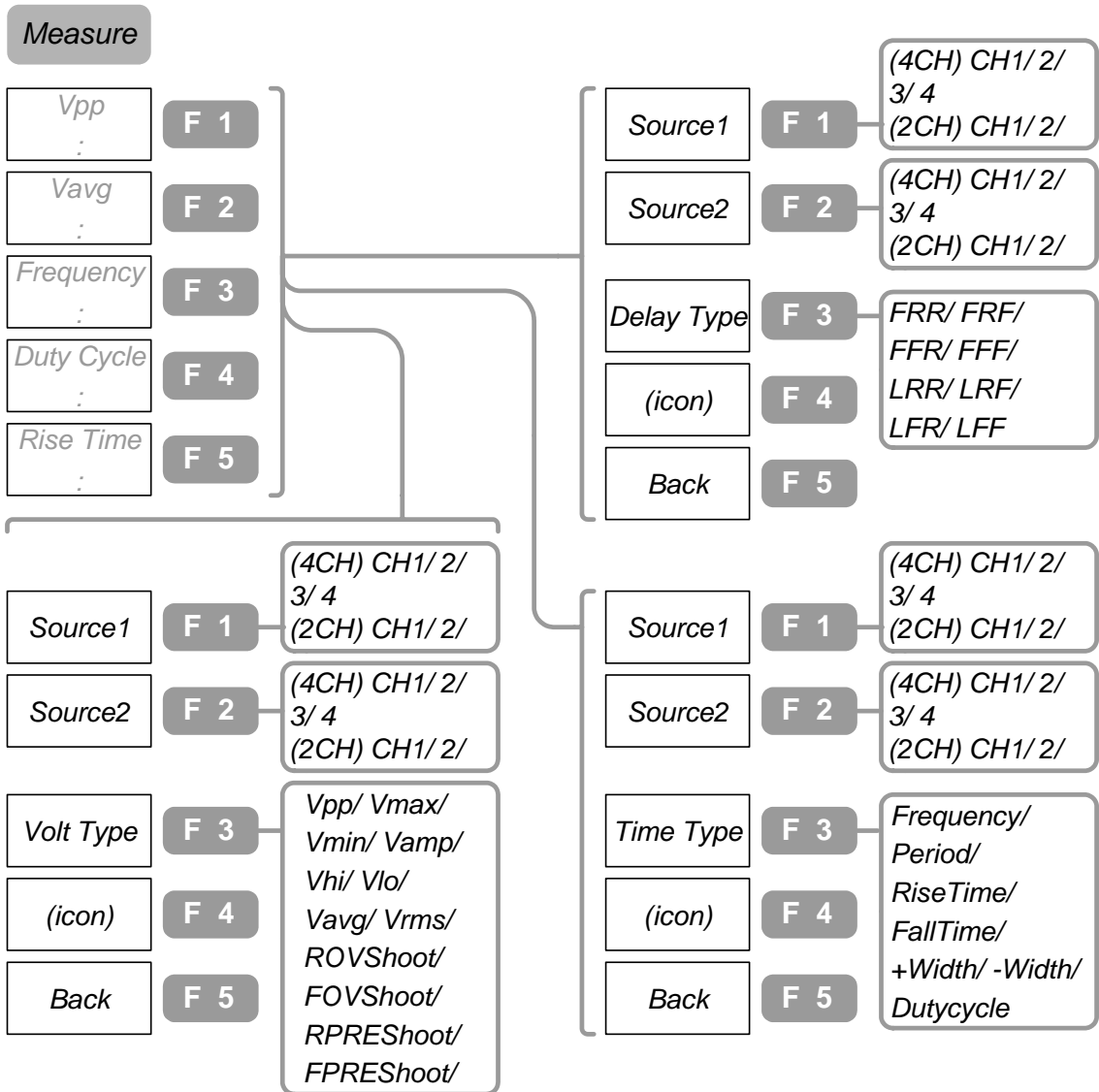

Save/ Recall (1 of 2)

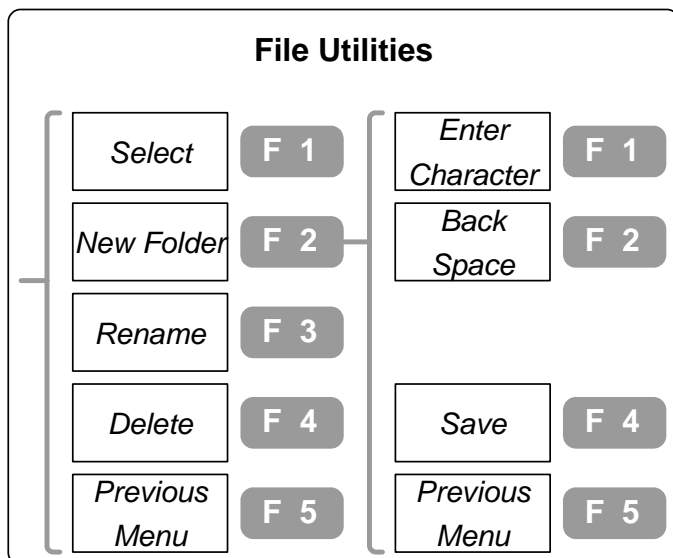
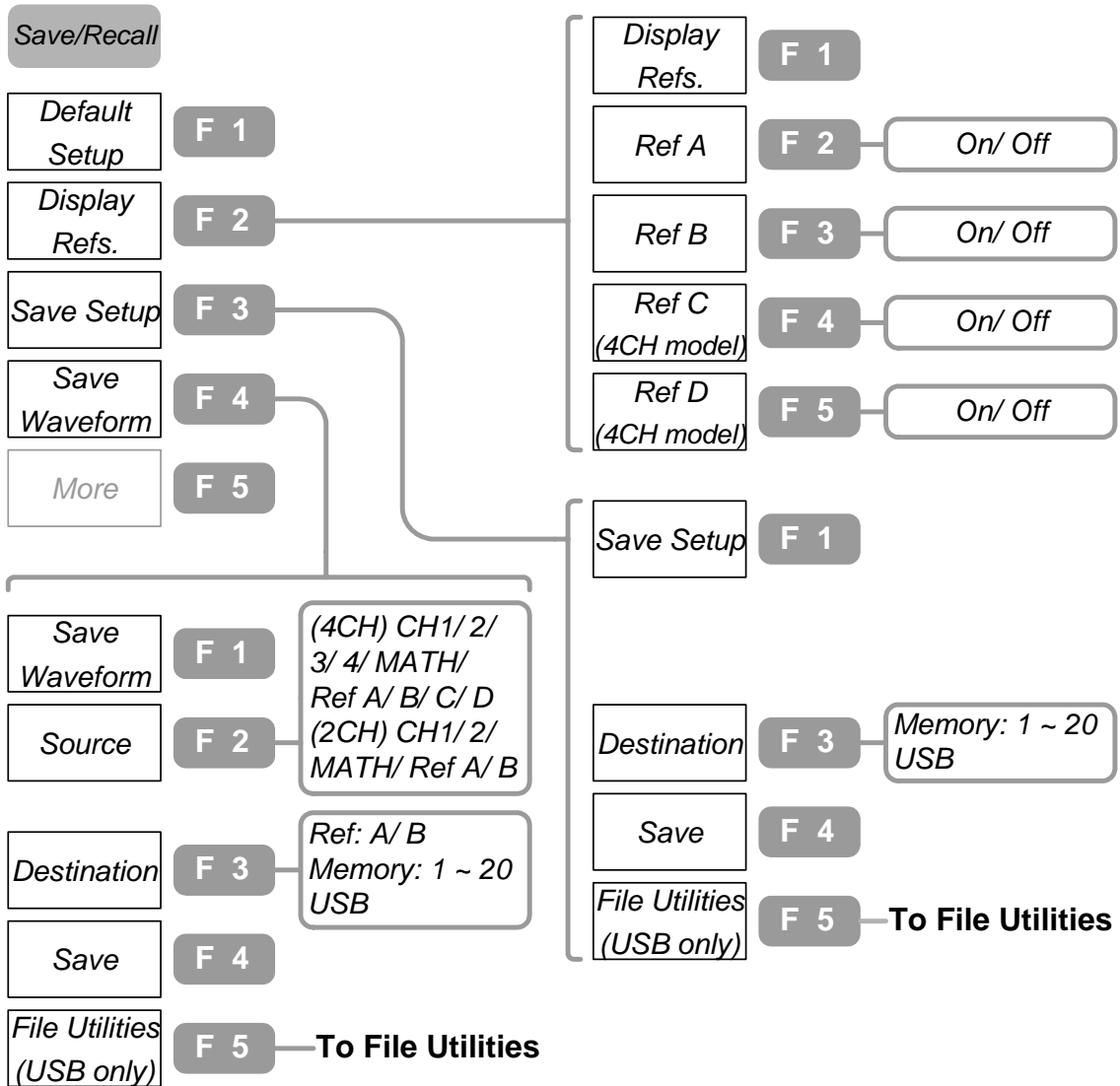

Save/ Recall (2 of 2)

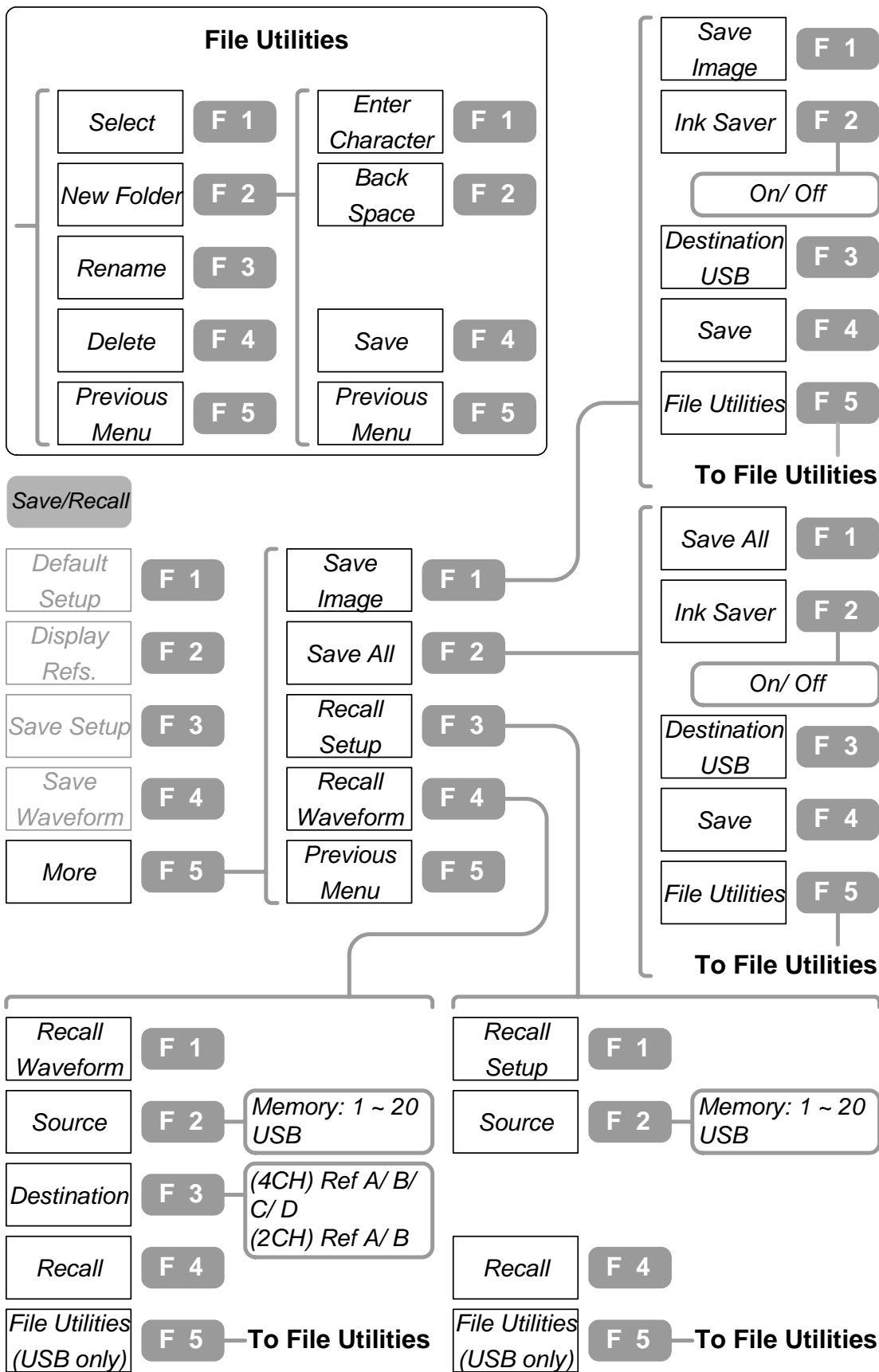

Trigger

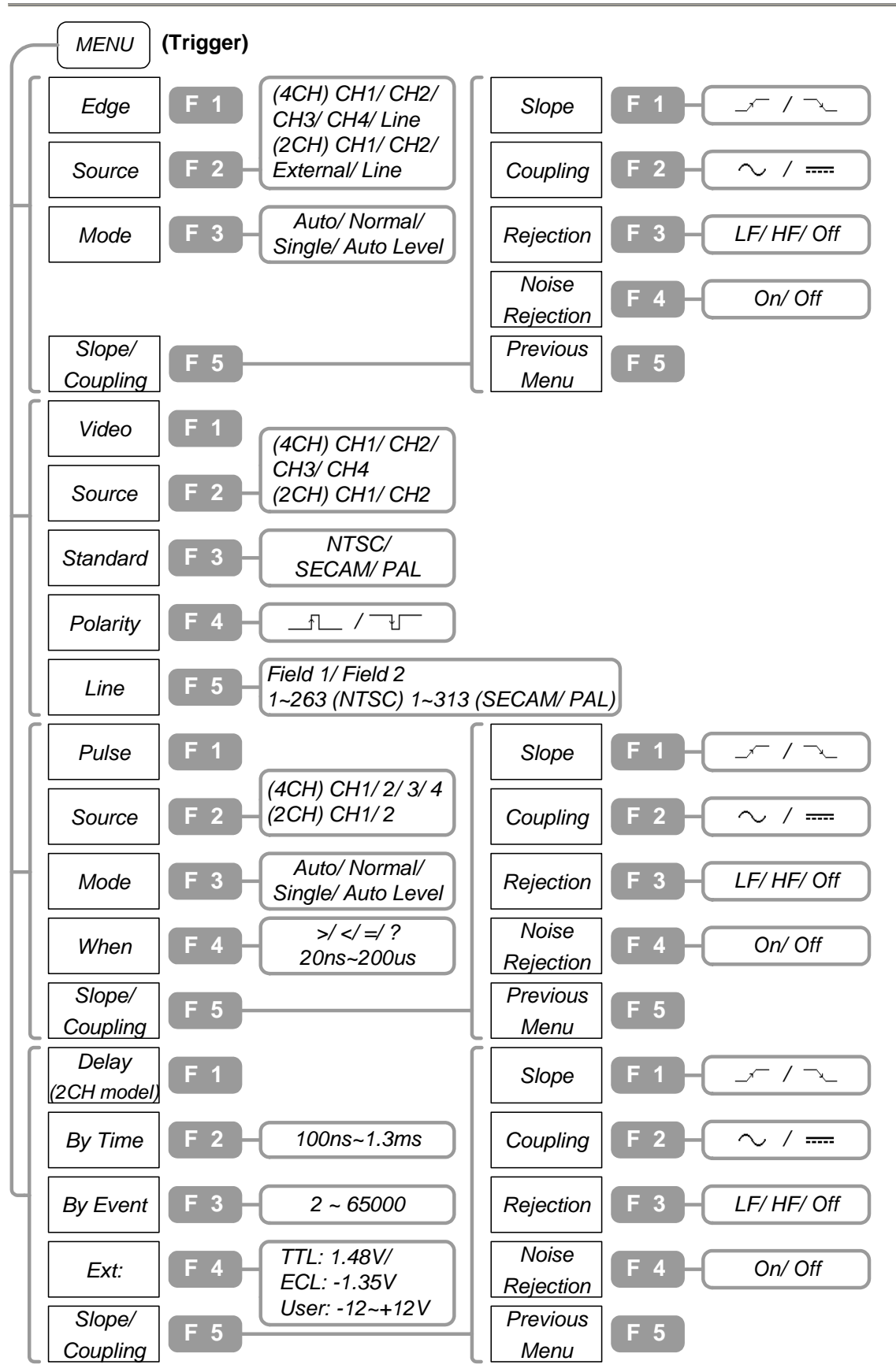

Utility (1 of 3)

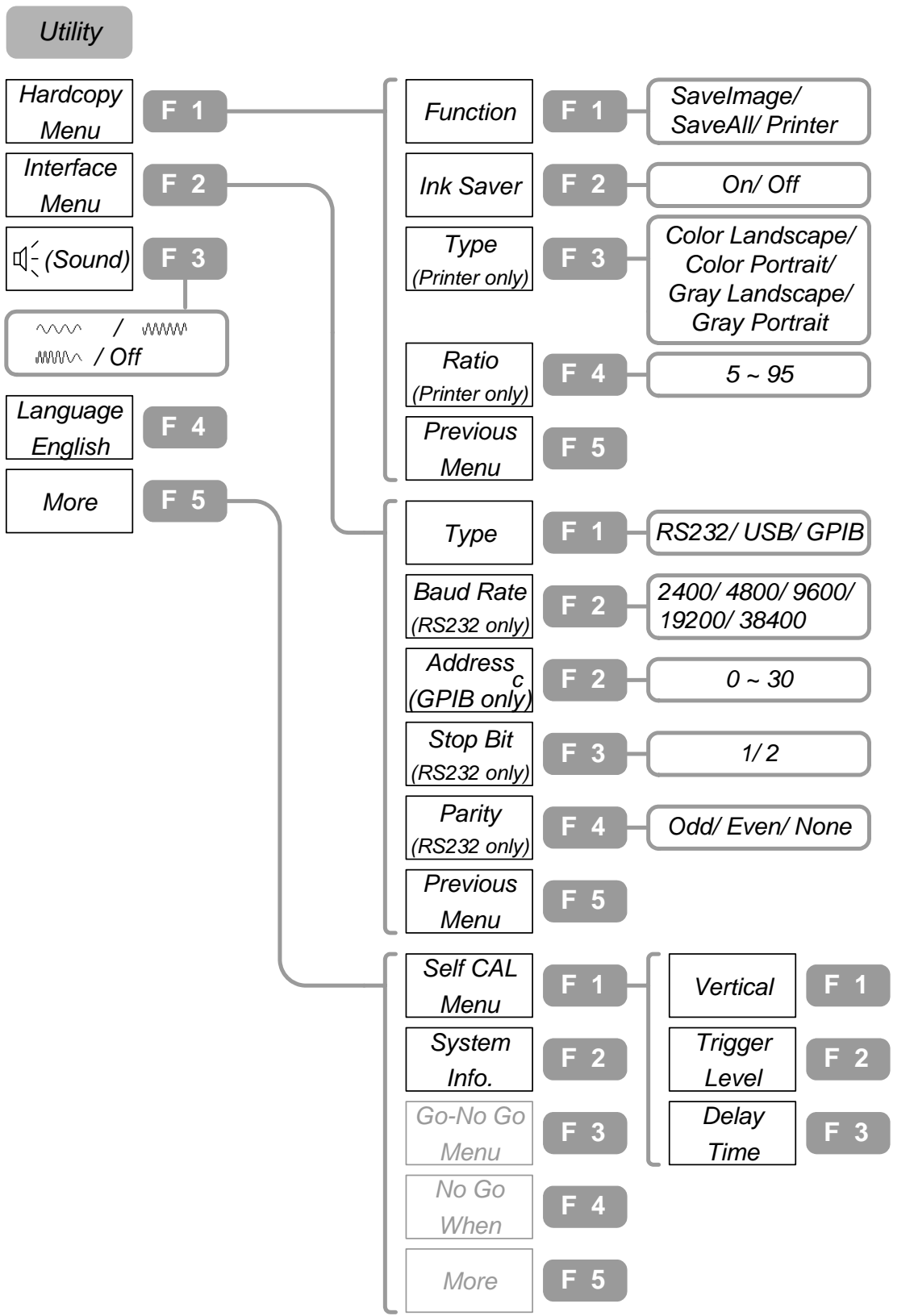

Utility (2 of 3)

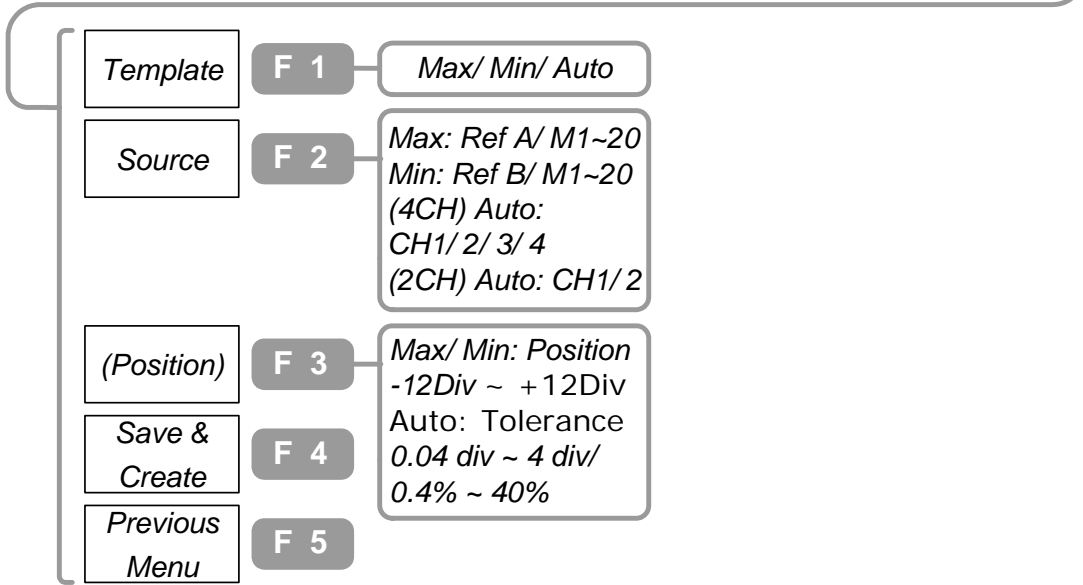
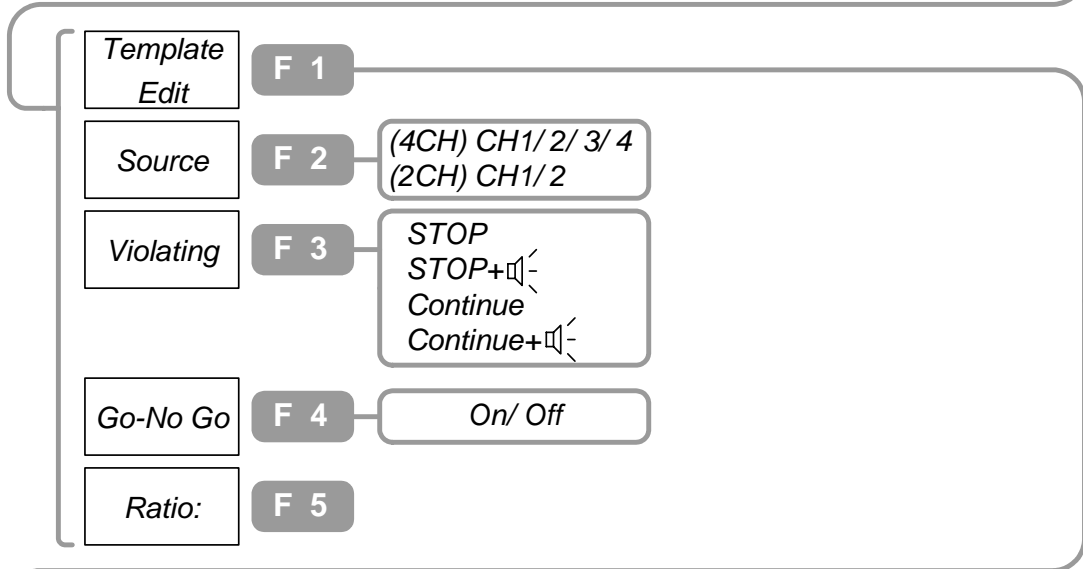
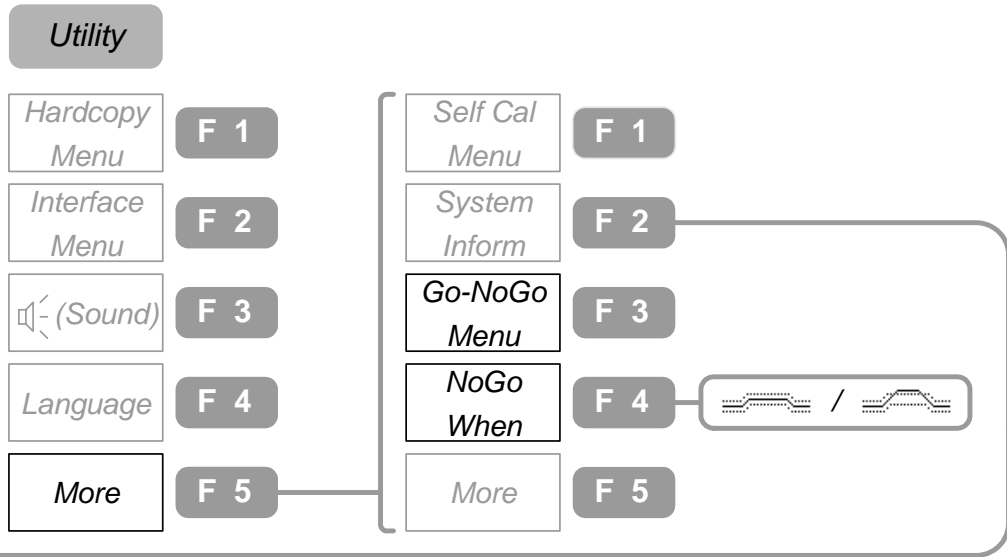

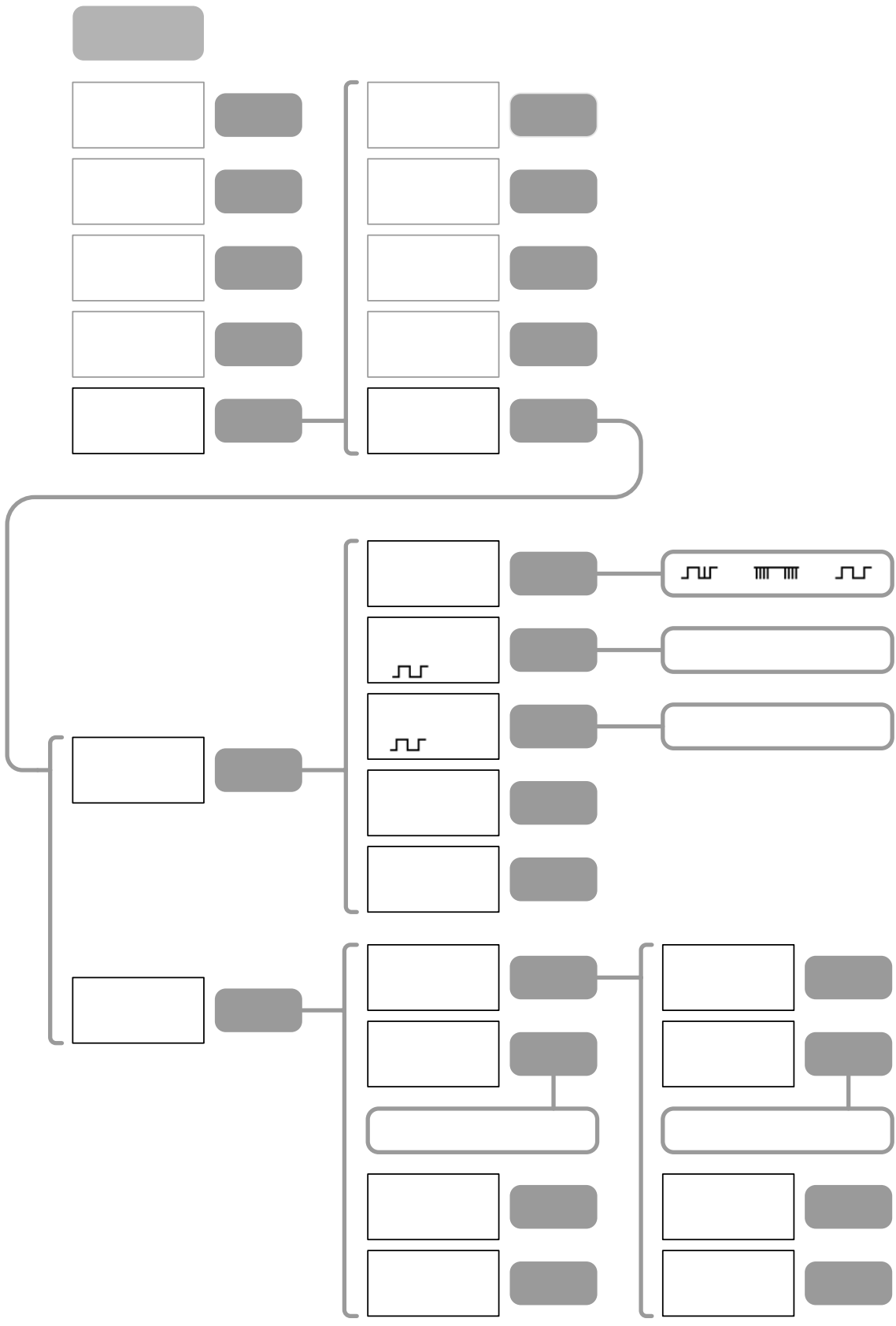

Utility (3 of 3)

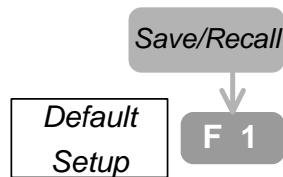

Default Settings



These are the factory installed settings that appear when pressing Save/Recall key→F1 (Default Setup).

Acquisition	Mode: Normal	Memory Length: 500
Channel (Vertical)	Scale: 2V/Div Coupling: DC BW Limit: Off	Invert: Off Probe Attenuation: x1
Cursor	Source: CH1 Vertical: None	Horizontal: None
Display	Type: dots Graticule: 	Accumulate: Off
Go-NoGo	Go-NoGo: Off NoGo when: 	Source: CH1 Violating: Stop
Horizontal	Scale: 2.5us/Div	Mode: Main Timebase
Math	Type: + Position: 0.00 Div	Channel: CH1+CH2 Unit/Div: 2V
Measure	Source1: CH1 Volt type: VPP Delay type: FRR	Source2: CH2 Time Type: Frequency
Program	Mode: Edit Item: Memory	Step: 1
Trigger	Type: Edge Mode: Auto Coupling: DC Noise Rejection : Off	Source: Channel1 Slope:  Rejection: Off
Utility	Hardcopy: SaveImage, Inksaver Off Sound: Off	Interface: GPIB, Address 8

Configure the Settings

Acquisition	Select the Acquisition mode	41
	Select the waveform memory length	43
	Relationship between Sampling rate, Memory length, and Timebase	44
<hr/>		
Cursor	Select the horizontal cursor type	45
	Select the vertical cursor type	47
<hr/>		
Display	Select the vector/dot waveform	49
	View accumulated waveform	50
	Set the display contrast	51
	Freeze the waveform.....	51
	Select the display grid type	52
	Turn Off the display menu	53
<hr/>		
Horizontal View	Roll the horizontal view	54
	Zoom the horizontal view.....	54
	View in XY mode.....	55
<hr/>		
Vertical View	Select the coupling method.....	56
	Invert the waveform	57
	Limit the frequency bandwidth.....	58
	Select the probe attenuation	58
<hr/>		
Other Settings	Select the buzzer sound	59
	View the Help information.....	59

View the system information	60
Select the language	60
Set the Date	61
Set the Time	62
Battery Maintenance (Optional)	63

Acquisition

Acquisition process samples the analog input signal and converts it into digital format, later to be reconstructed into waveform.

Select the Acquisition mode

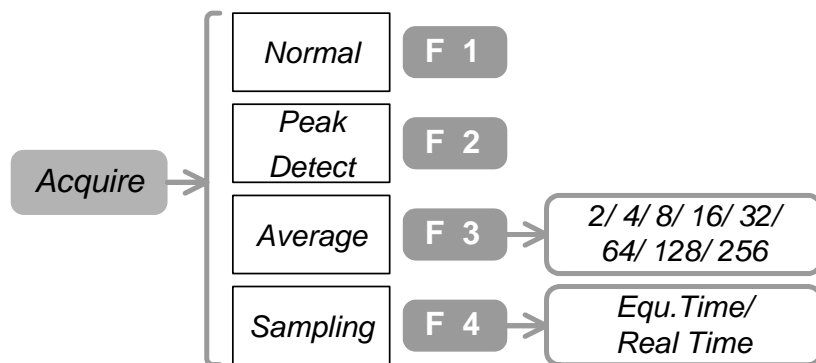

Panel operation



1. Press the Acquire key. Select the acquisition mode among F1~F3 and press it. The acquisition icon on the top right corner of the display changes accordingly.
2. (For Average mode) To select the number of samples, press F3 repeatedly.
3. To select the Sampling mode, press F4 repeatedly.

Range

Acquisition mode

Normal 	All the acquisition information is used to draw the waveform.
Peak Detect 	The minimum and maximum value pairs for each acquisition interval (bucket) are stored. Useful in catching abnormal glitches in the signal.
Average 	Multiple acquisitions are averaged to draw a noise-free waveform.

Average number
2, 4, 8, 16, 32, 64, 128, 256

Sampling mode

The first sample during each acquisition interval

is recorded.

Equ. Time	Equivalent Time sampling. GDS-2000 draws the waveform by accumulating the sample records. Use this only for repetitive signal.
Real Time	Real Time sampling. GDS-2000 draws the waveform from a single sample record.

Example

Normal mode

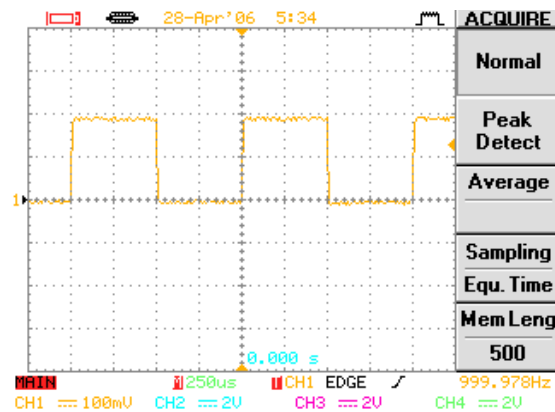

Peak Detect mode

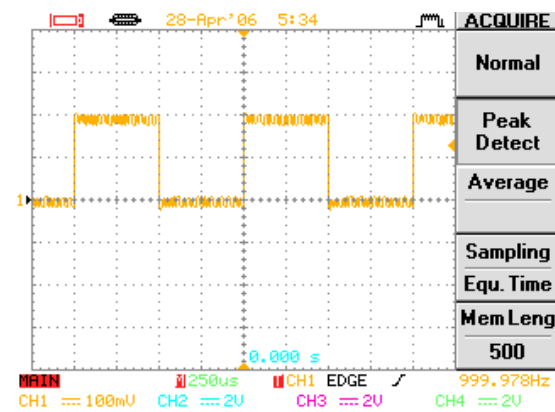

Average mode

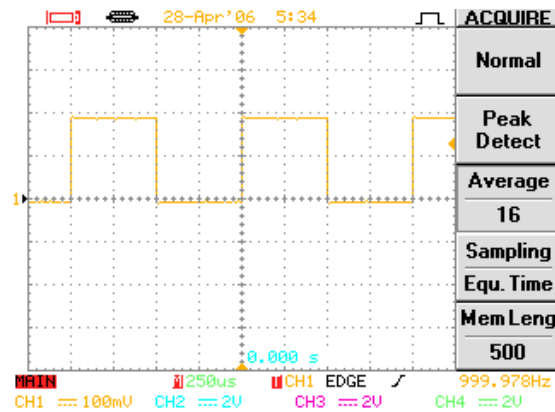

Select the waveform memory length

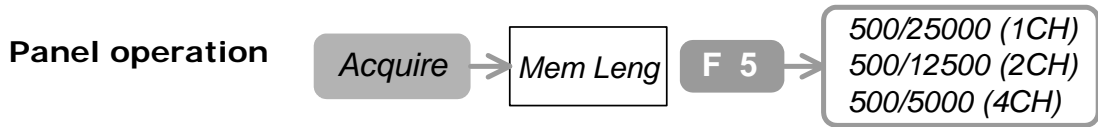

1. Press the Acquire key→F5.
2. To switch between short and long memory length, press F5 repeatedly.

Range		
500		Short memory length: useful when catching high frequency signal.
5000		Long memory length when three or four channels are active
12500		Long memory length when two channels are active
25000		Long memory length when only one channel is active

Relationship between Sampling rate, Memory length, and Timebase

Timebase (/div)	Memory length (points) vs Sampling rate (Sa/s)			
	500	5000	12500	25000
1ns	ET25G	N/A	N/A	N/A
2.5ns	ET10G	N/A	N/A	N/A
5ns	ET5G	N/A	N/A	N/A
10ns	ET2.5G	N/A	N/A	N/A
25ns	ET1G	N/A	N/A	N/A
50ns	ET500M	N/A	N/A	N/A
100ns	ET250M	N/A	N/A	N/A
250ns	100M	N/A	N/A	N/A
500ns	50M	N/A	N/A	N/A
1μs	25M	N/A	N/A	N/A
2.5μs	10M	100M	N/A	N/A
5μs	5M	50M	100M	N/A
10μs	2.5M	25M	50M	100M
25μs	1M	10M	25M	50M
50μs	500k	5M	10M	25M
100μs	250k	2.5M	5M	10M
250μs	100k	1M	2.5M	5M
500μs	50k	500k	1M	2.5M
1ms	25k	250k	500k	1M
2.5ms	10k	100k	250k	500k
5ms	5k	50k	100k	250k
10ms	2.5k	25k	50k	100k
25ms	1k	10k	25k	50k
50ms	500	5k	10k	25k
100ms	250	2.5k	5k	10k
250ms	100	1k	2.5k	5k
500ms	50	500	1k	2.5k
1s	25	250	500	1k
2.5s	10	100	250	500
5s	5	50	100	250
10s	2.5	25	50	100

Note that the display always shows 250 points (300 points when menu is turned off).

Cursor

Select the horizontal cursor type

Panel operation

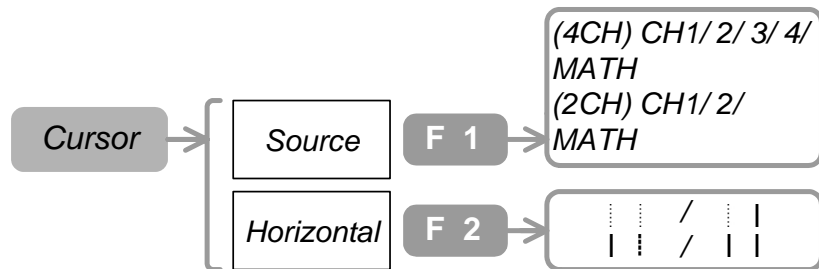

1. Press the Cursor key→F1. To select the signal, press F1 repeatedly.
2. To select the cursor to be activated, press F2 repeatedly.
3. To move the cursor, use the Variable knob .
4. The bottom right corner of the display shows the positions of two cursors (T1 & T2), their time difference (Δ), and the calculated frequency (f).

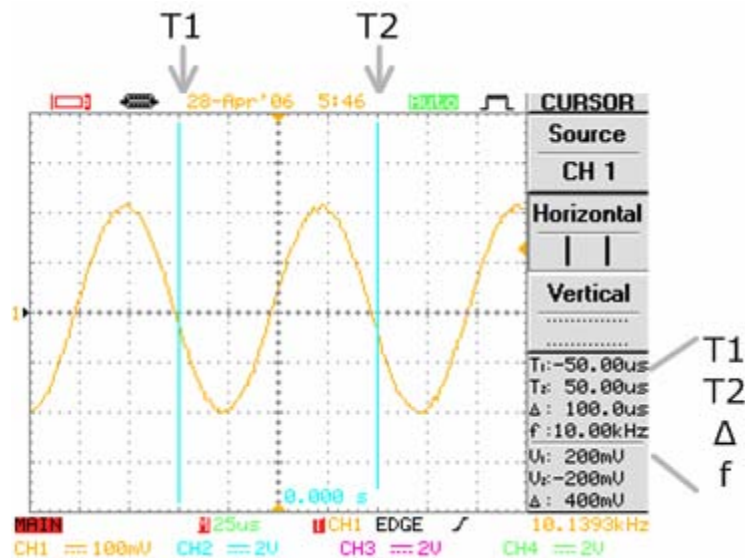

Range	Source	
	CH1~CH4 (4CH model)	Channel1~Channel2 waveform
	CH1~CH2 (2CH model)	Channel1~Channel2 waveform
	MATH	The waveform resulted from the math operation
	Horizontal (cursor type)	
	∴ ∴	Both T1 and T2 are invisible.
	∴	T2 is active, T1 is fixed. Variable knob moves only T2.
	∴	T1 is active, T2 is fixed. Variable knob moves only T1.
		Both T1 and T2 are active. Variable knob moves T1 and T2 together.

Select the vertical cursor type

Panel operation

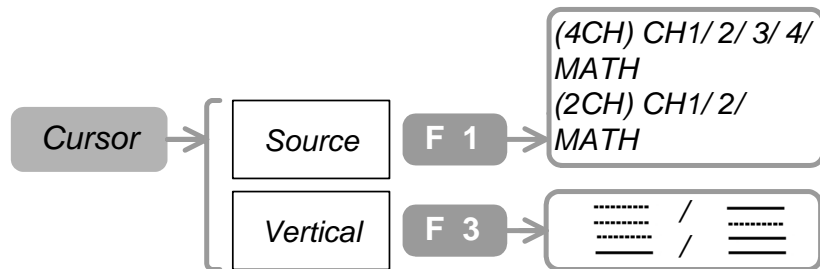

1. Press the Cursor key→F1. To select the signal, press F1 repeatedly.
2. To select the cursor to be activated, press F3 repeatedly.
3. To move the cursor, use the Variable knob .
4. The bottom right corner of the display shows the positions of two cursors (V1 & V2) and their voltage difference (Δ).

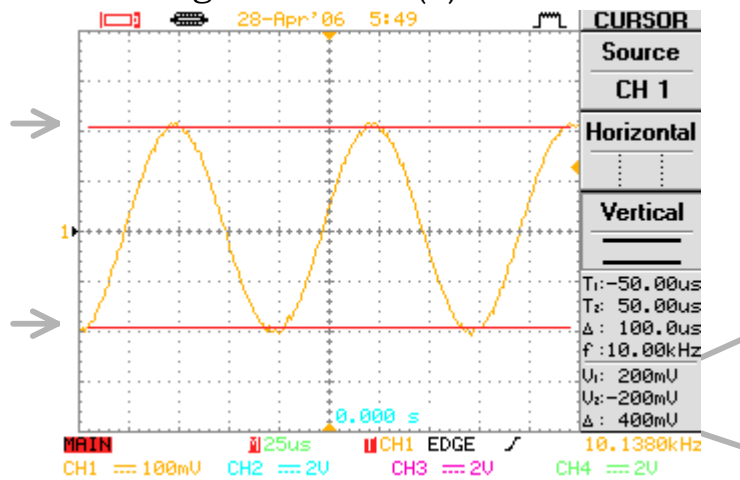

Range	Source	
	CH1~CH4 (4CH model)	Channel1~Channel4 waveform
	CH1~CH2 (2CH model)	Channel1~Channel2 waveform
	MATH	The waveform resulted from the Math operation.
Vertical (cursor type)		
	⋯⋯⋯	Both V1 and V2 are invisible.
	—	V2 is active, V1 is fixed. Variable knob moves only V2.
	⋯⋯⋯	V1 is active, V2 is fixed. Variable knob moves only V1.
	==	Both V1 and V2 are active. Variable knob moves V1 and V2 together.

Display

Select the vector/dot waveform

Panel operation



1. Press the Display key→F1.
2. To select the line format, press F1 repeatedly.

Range	Vectors	The sampled dots are connected to form a waveform line.
	Dots	Only the sampled dots are shown on the display

Example

Vectors

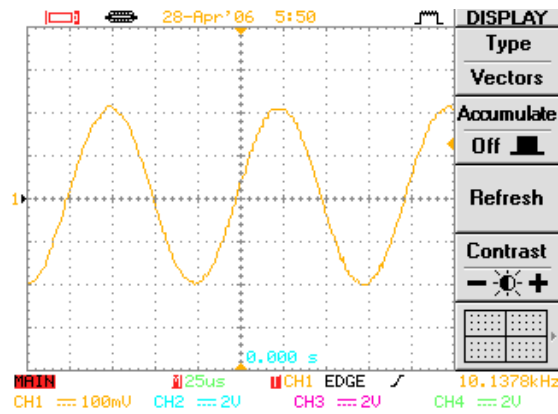

Dots

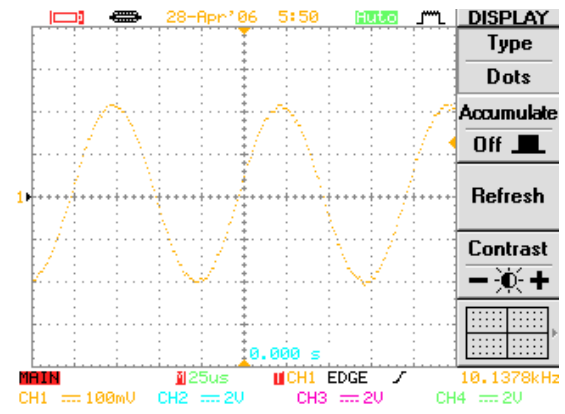

View accumulated waveform

Panel operation



1. Press the Display key→F2.
2. To turn Off accumulation, press F2 again.
3. To reset the accumulated waveform, press F3.

Range	On	The waveform is accumulated in the display to show the variation
	Off	The previous waveform is erased each time

Example

Accumulation Off

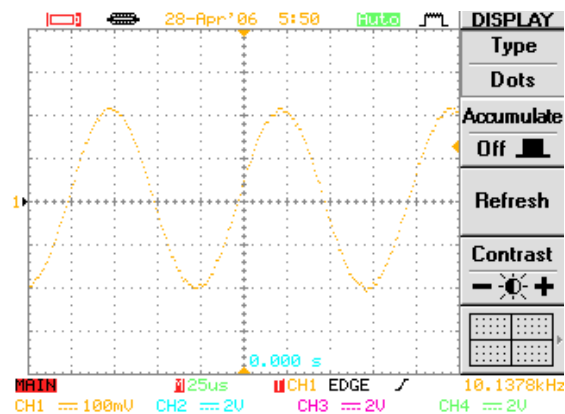

Accumulation On

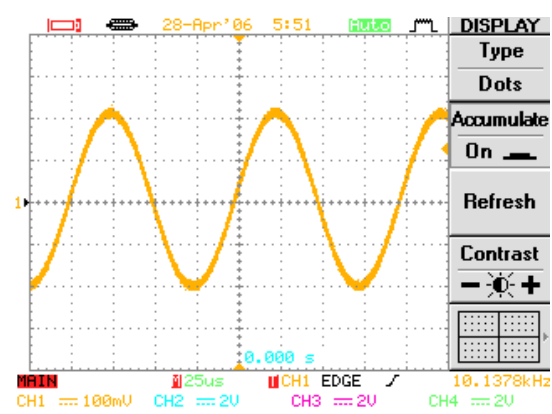

Set the display contrast

Panel operation



1. Press the Display key→F4.
 2. To change the contrast, use variable knob .
-

Freeze the waveform

Panel operation

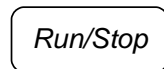

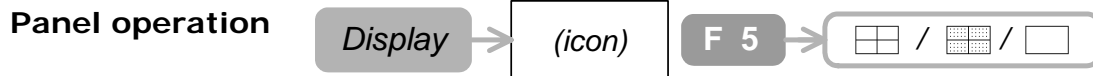

1. To freeze the waveform (and the trigger), press the Run/Stop button.
 2. To unfreeze the waveform, press the Run/Stop button again.
-

Select the display grid type



1. Press the Display key→F5.
2. To select the grid type, press F5 repeatedly.

Range		Only displays X and Y axis
		Displays full grid
		Only displays outer frame

Example

Full grid

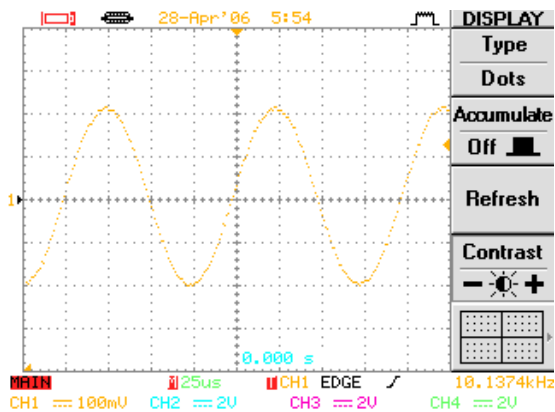

X and Y axis only

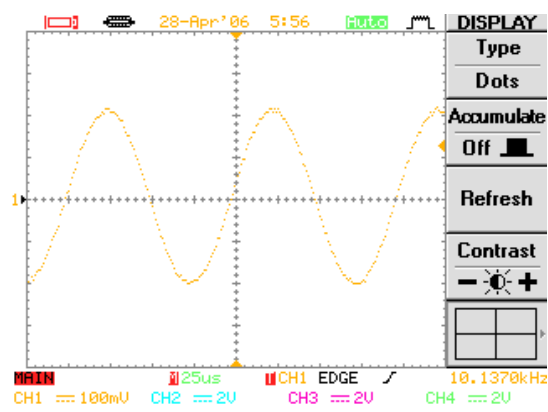

Outer frame only

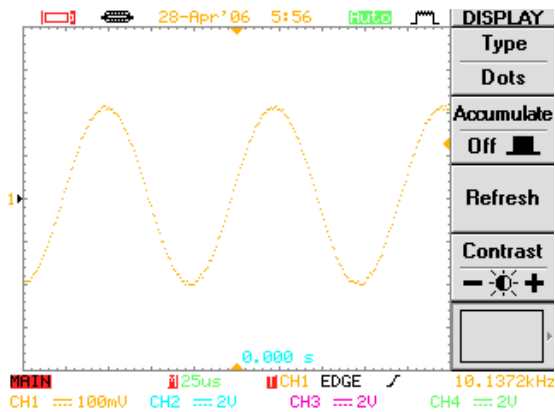

Turn Off the display menu

Panel operation

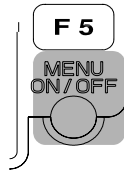

1. Press the MENU ON/OFF key.
2. To turn the menu On, press again.

Example

Menu On

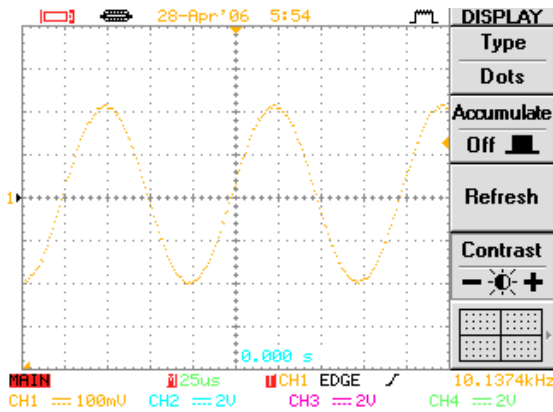

Menu Off

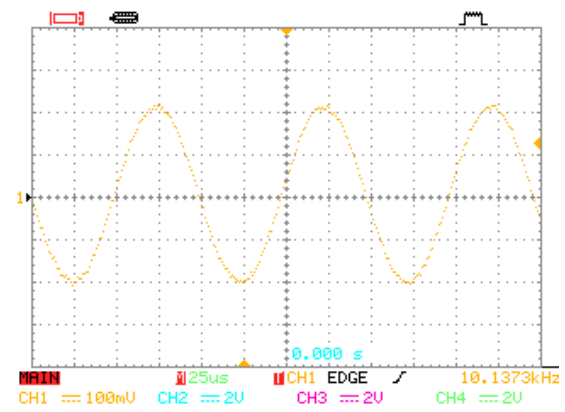

Horizontal View



Roll the horizontal view

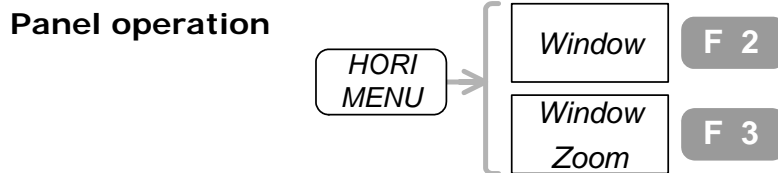

1. Press the Horizontal key→F4.
2. To go back to the default (main) view, press F1.

Zoom the horizontal view



1. Press the Horizontal key→F2.
2. To set the zoom range, use Time/Div knob .
3. To set the zoom range position, use Horizontal Position knob .
4. To zoom in, press F3.
5. The memory bar on the top of the display shows the zoomed portion of the entire waveform.





Range 1ns~1ms

View in XY mode

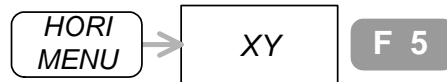
Not available for Channel 3 and Channel 4

Panel operation



1. Feed Channel1 (horizontal) and Channel2 (vertical) signal.
 2. Press the Horizontal key→F5.
 3. To set the horizontal scale and position, use Channel1 Volts/Div knob  and Position knob .
 4. To set the vertical scale and position, use Channel2 Volts/Div knob  and Position knob .
-

Vertical

Select the coupling method

Panel operation



1. Press the Channel key→F1.
2. To select the coupling, press F1 repeatedly.

Range

- AC coupling
- DC coupling
- Ground coupling

Example

Observe the AC portion of a signal using AC coupling

DC Coupling

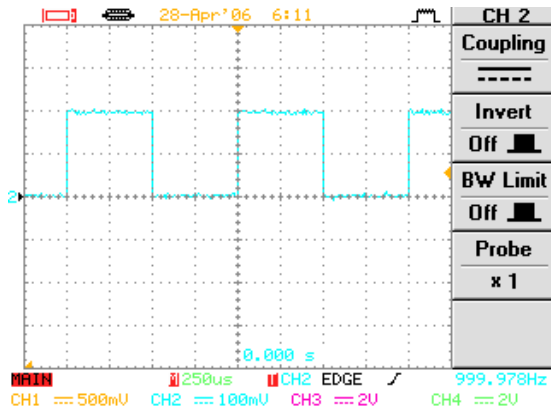

AC Coupling

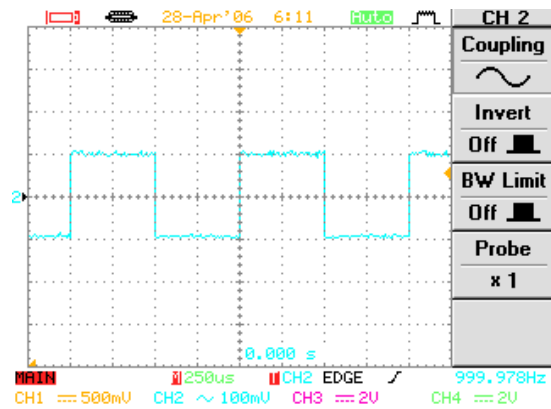

Invert the waveform

Panel operation



1. Press the Channel key→F2.
2. To cancel the effect, press F2 again.

Example

CH2 (lower waveform) Invert Off

CH2 Invert On

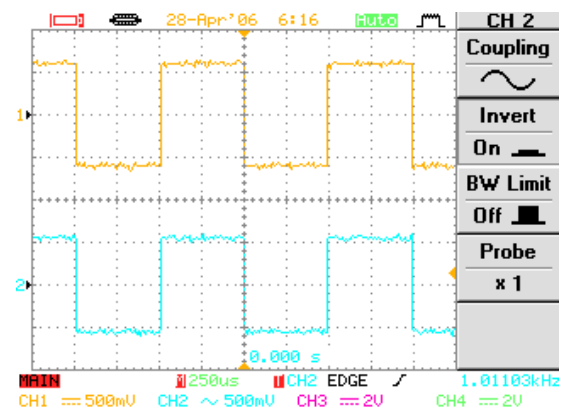
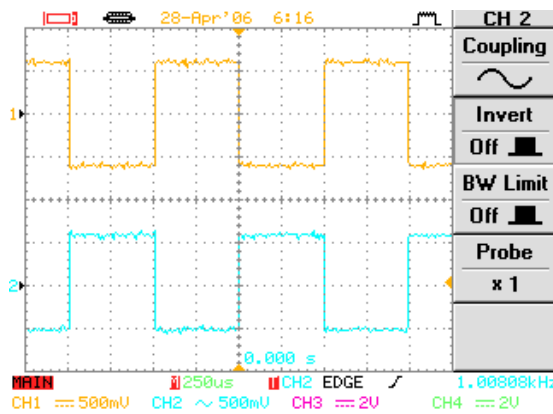

The trigger is also inverted.

Limit the frequency bandwidth



1. Press the Channel key→F3.
2. To cancel the effect, press F3 again.

Range	BW Limit On	Frequency bandwidth: 20MHz
	BW Limit Off	Frequency bandwidth: 100MHz

Select the probe attenuation

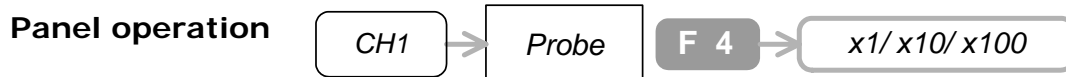

1. Press the Channel key→F4.
2. To select the attenuation level, press F4 repeatedly.
3. Vertical scale is adjusted accordingly.



Range	x1	No attenuation
	x10	Attenuation factor 10
	x100	Attenuation factor 100

Other Settings

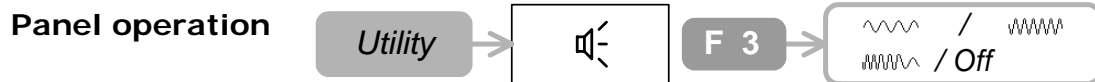
Select the buzzer sound

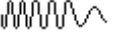

1. Press the Utility key→F3.
2. To select the buzzer setting, press F3 repeatedly.

Range		
		Low pitch
		High pitch
		Mixed pitch
	Off	No sound

View the Help information

GDS-2000 has built-in help accessible from the front panel.



1. Press the Help key. The waveform freezes and the front panel switches to “Help” mode.
2. To view the built-in help, select a key from the following and press it. The key functionality will be shown on the display.
Acquire, Cursor, Display, Measure, Program, Utility
3. To go back to normal operation, press the Help key again.

View the system information

Panel operation



1. Press the Utility key→F5→F2.
2. The following information is shown.
Model name, Serial No, Firmware version, battery voltage and capacity (optional).

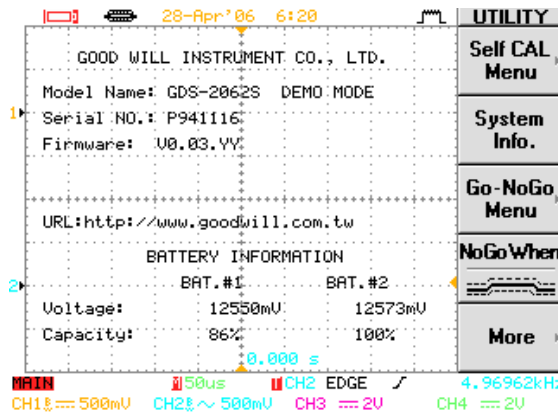

3. To go back to the signal view, press the other key.

Select the language

Panel operation

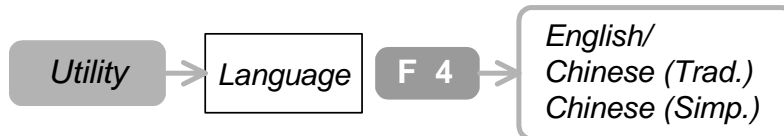

Press the Utility key→F4. To select the language, press F4 repeatedly.

Range

- English
- Chinese Traditional
- Chinese Simplified

Set the Date

Panel operation

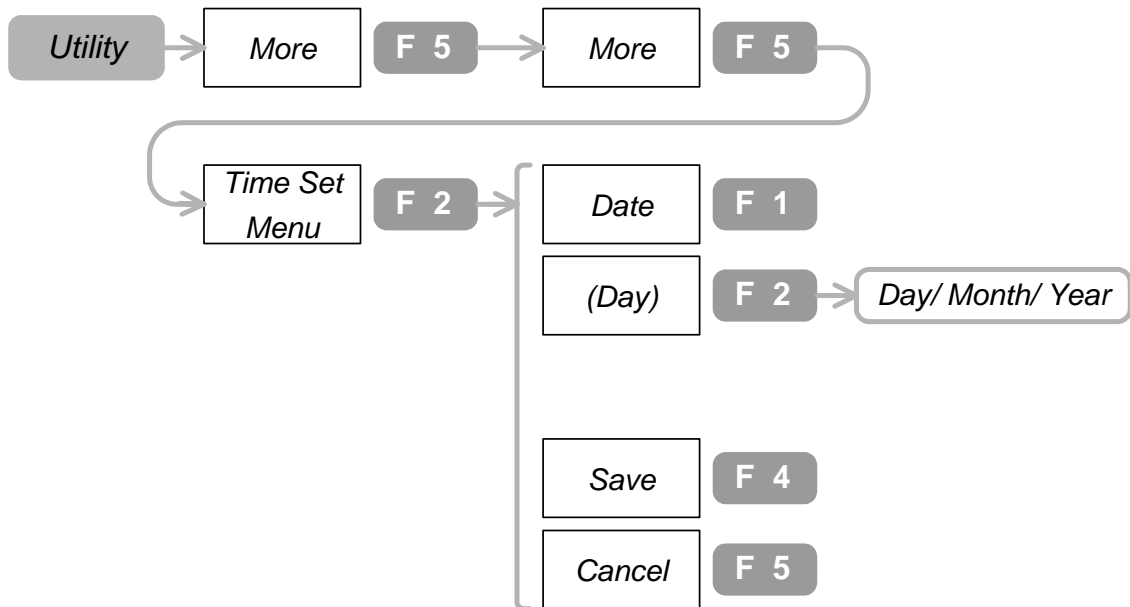



1. Press the Utility key→F5→F5→F2. Press F1 again if “Date” does not appear.
2. To select the date item, press F2 repeatedly.
3. To set the parameter, use the Variable knob .
4. To save the change, press F4 twice.
5. To go back to the previous menu, press F5.

Range	Day	1~31
	Month	1~12
	Year	2000~2037

Set the Time

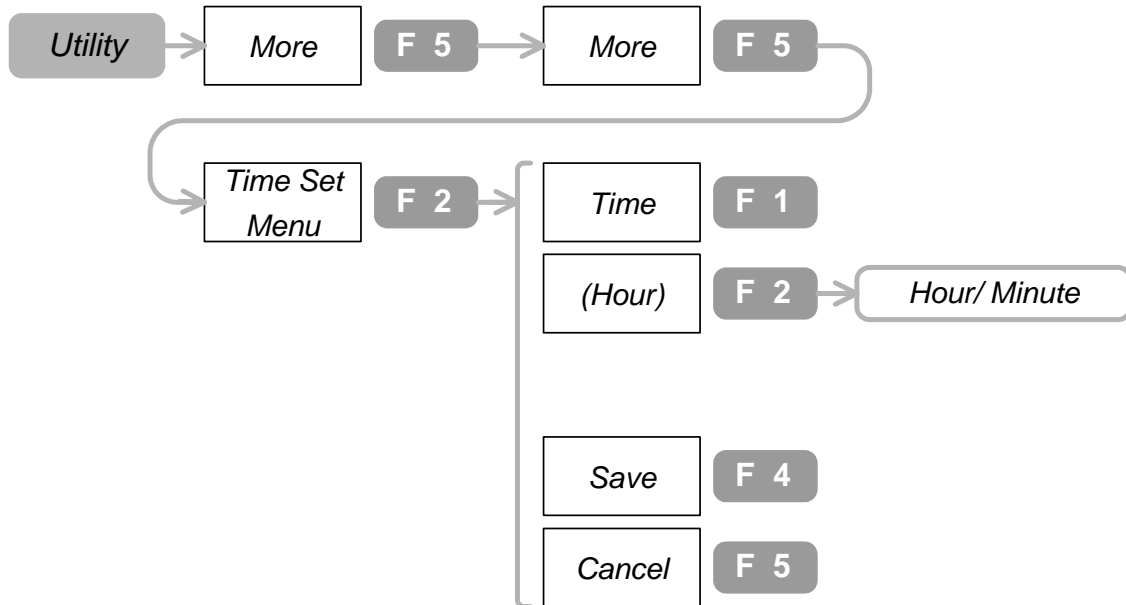
Panel operation



1. Press the Utility key→F5→F5→F2→F1. Press F1 again if “Time” does not appear.
2. To select the time item, press F2.
3. To set the parameter, use the Variable knob .
4. To save the change, press F4 twice.
5. To go back to the previous menu, press F5.

Range	Hour	0~23
	Minute	0~59

Battery Maintenance (Optional)

The battery is a factory-installed optional item. Contact your local dealer for purchase and installation.

Specification Li-Ion, 10.8V 1600mAh per pack (two packs for one GDS-2000 unit)
 Charging time: Twelve hours approx.
 Operation time: Three hours approx.

Battery information To view battery status, press Utility key→F5→F2.

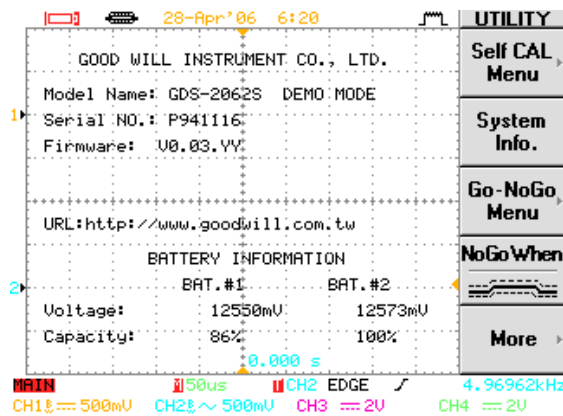

Battery voltage and charge information is shown on the lower pane.

When not in use Take the batteries out of the unit to prolong the battery life.

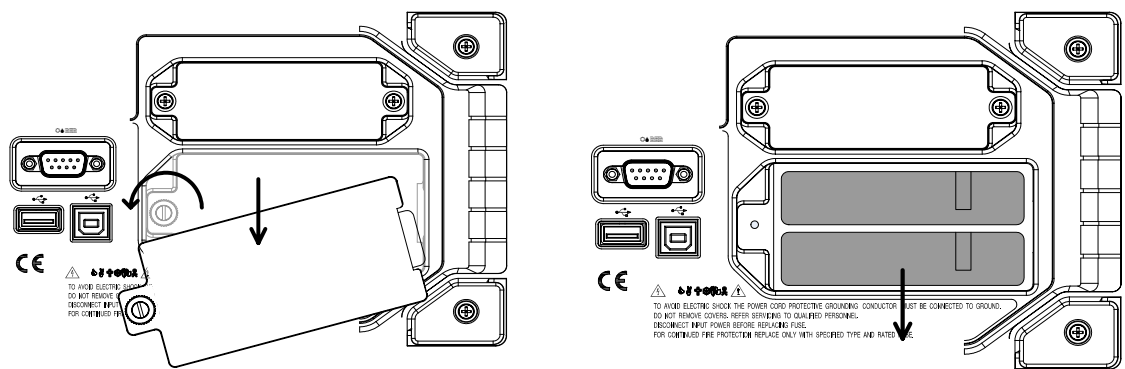

Measurements

Automatic Measurements	Auto Set 65 Run automatic measurements 66 View automatic measurement results 69
Go-No Go Test	Edit Go-No Go test condition 70 Run Go-No Go test..... 73
Math Operation	Add/ Subtract/ Multiply/ Divide signals 74 Run FFT operation 75
Program and Play	Edit the program steps 76 Play the program..... 77
Trigger	Use Edge trigger..... 78 Use Video trigger..... 80 Use Pulse width trigger..... 81 Use Advanced delay trigger..... 83

Automatic Measurements

Auto Set

Auto Set automatically finds the appropriate settings (vertical, horizontal, trigger) for the input signals.

Limitation: Signals under 30mV or 30Hz would not be configured.

Panel Operation

Auto Set

The following is the Auto Set configuration.







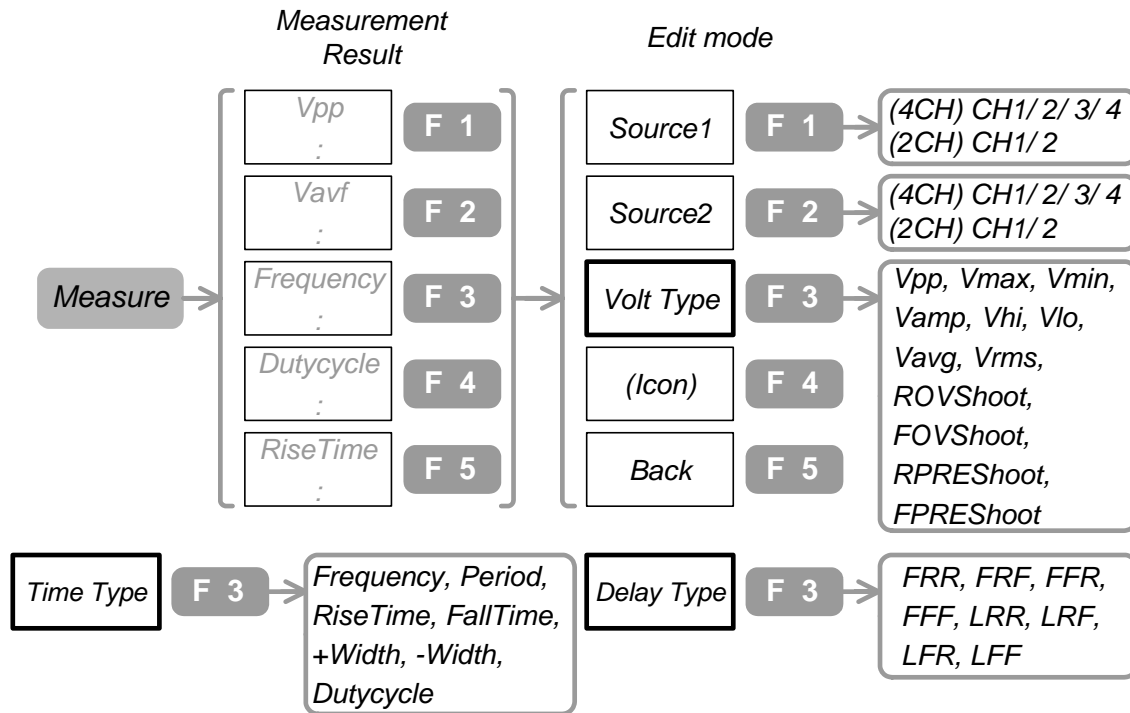



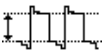

Acquisition	Mode: Stop after:	Sample RUN/STOP button only
Display	Style: Format:	Vectors YT
Horizontal	Scale: Position:	Signal frequency dependent Centered within the graticule window
Trigger	Coupling: Position: Slope: Type: Source: Level:	DC Center Positive Edge Highest frequency Midpoint of data for the trigger source
Vertical	Bandwidth: Offset: Coupling: Scale:	Full 0 Signal dependent Signal dependent

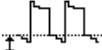
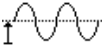

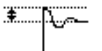
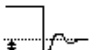

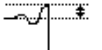
Run automatic measurements

Panel operation











1. Press the Measure key. F1 to F5 shows the result from the previous measurement.
2. Press any of F1~F5. The menu switches to edit mode.
3. To select the first measuring object channel, press F1 repeatedly.
4. To select the second measuring object channel, press F2 repeatedly.
5. To select the measurement type, press F3 repeatedly.
6. To select the measurement parameter, use the Variable knob . The corresponding icon is shown on F4.
7. To go back to the measurement result view, press F5.

Range	Source 1, 2	
	(4CH) CH1~CH4	(4CH model) Channel1~Channel2
	(2CH) CH1,CH2	(2CH model) Channel1,Channel2
	Volt type	
Vpp		Difference between positive and negative peak voltage. (=Vmax-Vmin)
Vmax		Positive peak voltage.
Vmin		Negative peak voltage.
Vamp		Difference between global high and global low voltage. (=Vhi - Vlo).
Vhi		Global high voltage.
Vlo		Global low voltage.
Vavg		Averaged voltage of the first cycle.
Vrms		Root Mean Square voltage.
ROVShoot		Rise Overshoot voltage.
FOVShoot		Fall Overshoot voltage.
RPREShoot		Rise Preshoot voltage.
FPREShoot		Fall Preshoot voltage.
	Time Type	
Freq		Frequency of the waveform.
Period		Waveform cycle time. (=1/Freq)
Risetime		Rising time of the pulse (~90%)

Falltime		Falling time of the pulse (90%~)
+Width		Positive pulse width.
-Width		Negative pulse width.
Duty Cycle		The ratio of the signal pulse compared with the whole cycle. (=100x Pulse Width/Cycle)

Delay Type

FRR		Time between Source1 signal first rising edge and Source2 signal first rising edge.
FRF		Time between Source1 signal first rising edge and Source2 signal first falling edge.
FFR		Time between Source1 signal first falling edge and Source2 signal first rising edge.
FFF		Time between Source1 signal first falling edge and Source2 signal first falling edge.
LRR		Time between Source1 signal first rising edge and Source2 signal last rising edge.
LRF		Time between Source1 signal first rising edge and Source2 signal last falling edge.
LFR		Time between Source1 signal first falling edge and Source2 signal last rising edge.
LFF		Time between Source1 signal first falling edge and Source2 signal last falling edge.

View automatic measurement results

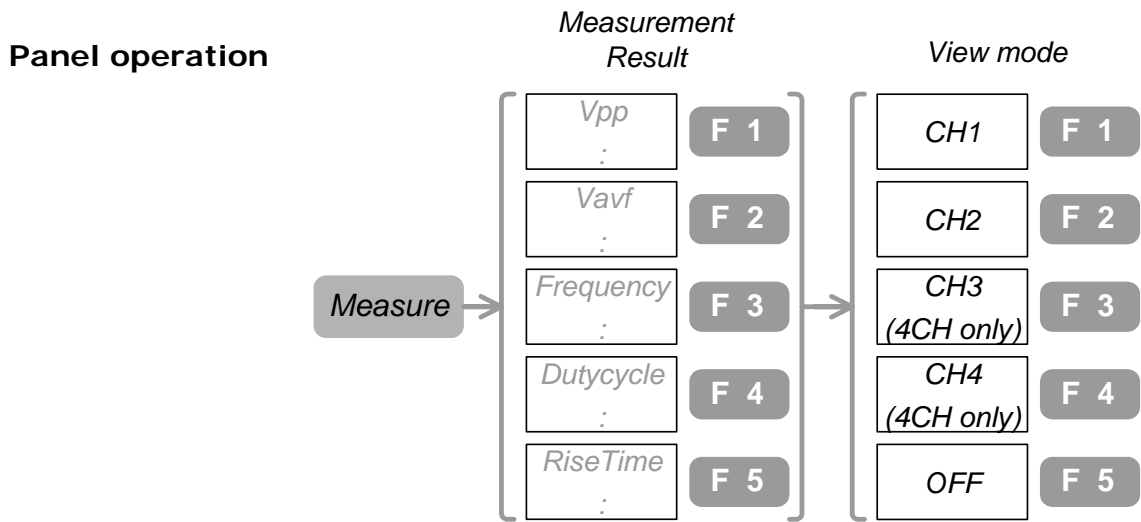

1. Two viewing modes are available: selected results on the menu pane (press Measure key once) and full list of results on the display (press Measure key again).
2. To view the full result, press the Measure key repeatedly until the view mode appears.
3. To view the measurement results, select the channel from F1~F4 and press it. GDS-2000 runs all the applicable Voltage and Time type measurements, shows the result on the display.

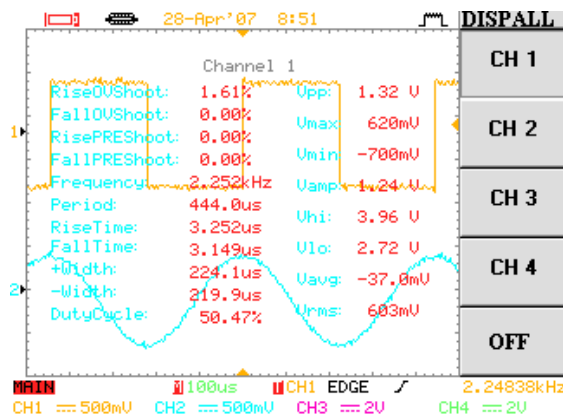



4. To bring back the signal view again, press F5.

Go-No Go Test

Edit Go-No Go test condition

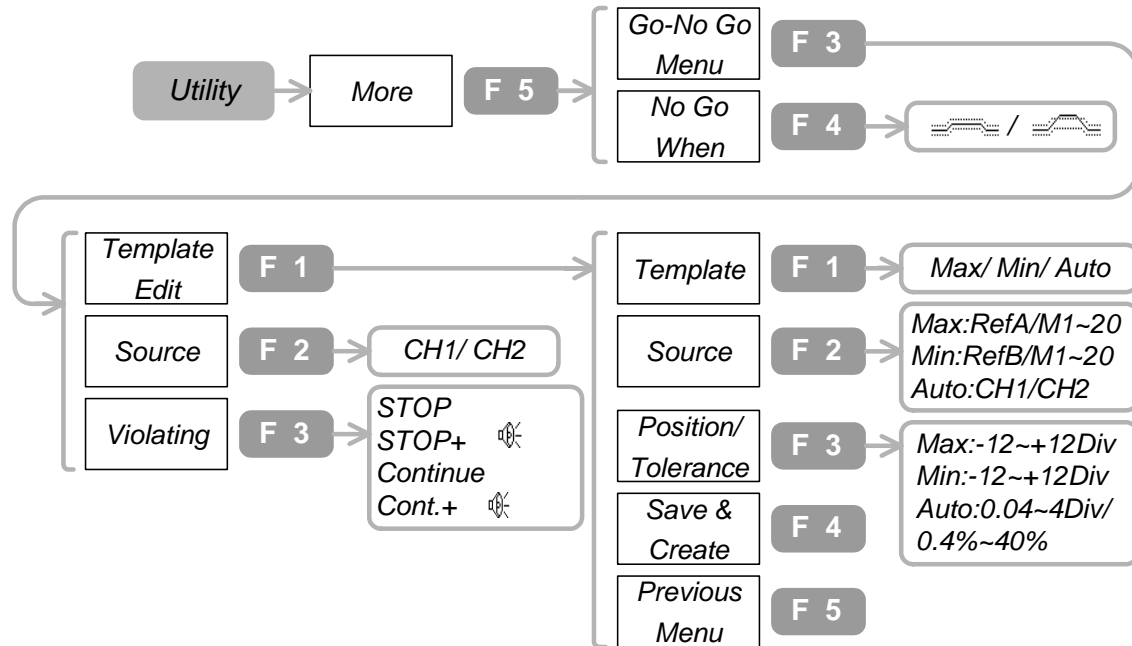
Panel operation



1. Press the Utility key→F5. To select No Go When (violation condition), press F4 repeatedly.
2. Press F3 and go into Go-No Go menu.
3. To select the test subject signal, press F2 repeatedly.
4. To select the violation event, press F3 repeatedly.
5. Press F1 and go into template edit menu.
6. To select the template, press F1 repeatedly.
7. To select the template source, press F2 repeatedly.
8. To select the template position (Maximum/Minimum) or tolerance (Auto), use Variable knob .
9. To save the edited template, press F4.

10. To go back to the previous menu, press F5.

Range

Go-No Go When (violation condition)

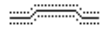

No Go means the subject signal is within the template.

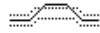

No Go means the subject signal is violating the template.

Template

Max

Sets the maximum side of the template.

Template source

RefA: Reference waveform that has to be stored in advance.

M1~20: Templates stored in advance in internal memory.

To store a waveform (template) internally, see page **Error! Bookmark not defined.**

Template position

±12/Div

Min

Sets the minimum side of the template.

Template source

RefB: Reference waveform that has to be stored in advance.

M1~20: Templates stored in advance in internal memory.

To store a waveform (template) internally, see page **Error! Bookmark not defined.**

Template position

±12/Div

Auto Automatically creates the maximum and minimum template from an incoming signal, specifying the margin (tolerance) around the waveform.

Template source

CH1: Use Channel1 signal

CH2: Use Channel2 signal

Template tolerance

0.4%~40%

Creating a template in Auto mode

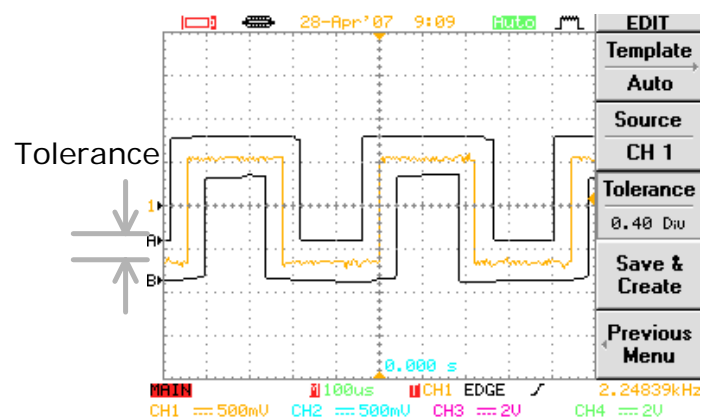

Source signal

CH1 Channel1 as the subject of test

CH2 Channel2 as the subject of test

Violation Condition

Stop The test stops in case of violation.

Stop+  The test stops with a buzzer sound in case of violation.

Continue The test continues even in case of violation.

Cont.+  The test continues but with a buzzer sound in case of violation.

Run Go-No Go test

Panel operation

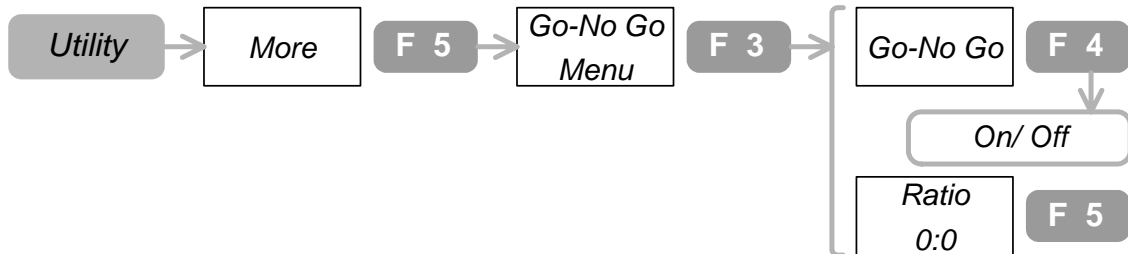

1. Edit the test condition. See page70.
2. Press the Utility key→F5→F3.
3. To run Go-No Go test, press F4.
4. To stop Go-No Go test, press F4 again.
5. The test result is shown on F5 as (Number of test: Number of violation).
6. GDS-2000 can output the test result as a 10us pulse signal from the rear panel.



Rear panel output terminal (Open Collector)

Math Operation

Add/ Subtract/ Multiply/ Divide signals

Panel operation

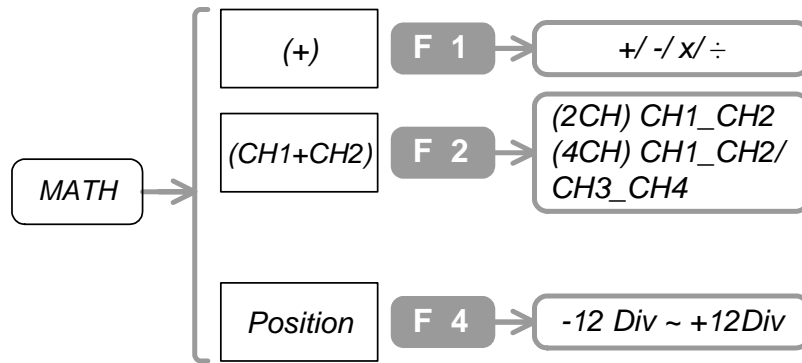

1. Press the Math key.
2. To select the operation type, press F1 repeatedly.
3. (only for 4CH model) To select the channel pairs, press F2 repeatedly.
4. To set the position of the resulted waveform, press F4. Then use the Variable knob .

Range

Math Operation type

+	Addition
-	Subtraction
×	Multiplication
÷	Division

Channel Pair

CH1_CH2	Math operation between Channel1 and Channel2
CH3_CH4	Math operation between Channel3 and Channel4 (only for 4CH model)

Position

-12Div~+12Div

Run FFT operation

Not available for Channel3 and Channel4

Panel operation

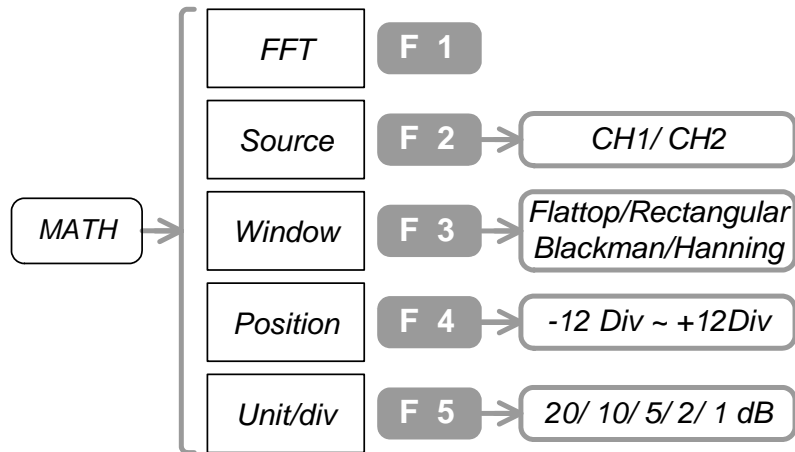

1. Press the Math key→F1. Press F1 repeatedly until “FFT” comes up.
2. To select the subject channel, press F2 repeatedly.
3. To select the FFT window type, press F3 repeatedly.
4. To set the position of the resulted waveform, press F4. Then use the Variable knob.
5. To select the amplitude scale, press F5 repeatedly.

Range

FFT Window

Rectangular	Suitable for transient analysis.
Blackman	Frequency resolution is not as good as Hanning, but comes with better sidelobe rejection.
Hanning	Higher frequency resolution.
Flattop	Higher magnitude accuracy.

Position

-12Div~+12Div

Amplitude scale



1, 2, 5, 10, 20 dB/Div

Program and Play

Edit the program steps

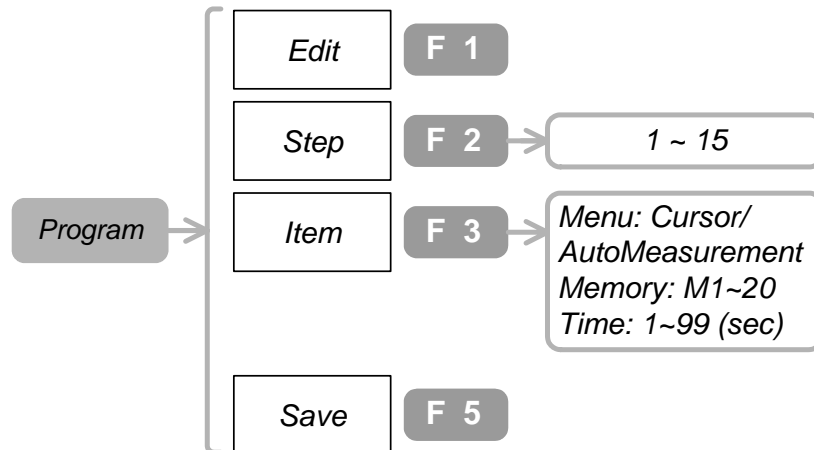
Panel operation





1. Press the Program key→F1. In case “Edit” menu does not appear, press F1 again.
2. To select the step to be edited, press F2. Then use Variable knob . The cursor in the display also moves accordingly.
3. To select the program item, press F3. Then use Variable knob  and select the parameter.
4. To save the edited step, press F5.
5. Repeat the above for the other steps.

Range	Step (number)	
		1~20
	Item	
	Menu	“AutoMeasure” or “Cursor”.
	Memory	M1~M20 predefined waveforms. To store waveforms, see pagexx.
	Time	1~99 seconds for each step.

Play the program

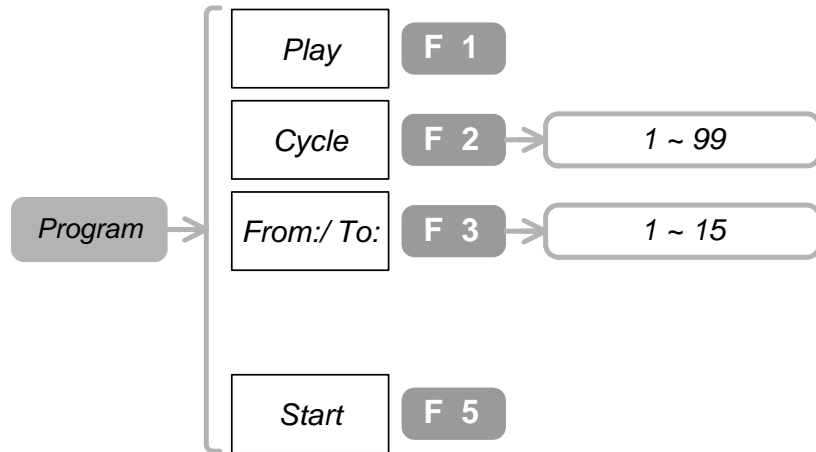
Panel operation

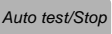

1. Edit the program. See page76.
2. Press Program key→F1. In case “Play” menu does not appear, press F1 again.
3. To set the number of repetition (cycle), press F2.Then use the Variable knob○.
4. To select “From:” step (beginning of the program), press F3. In case “From:” menu does not appear, press F3 again. Then use the Variable knob○.
5. To select “To:” step (end of the program), press F3. In case “To:” menu does not appear, press F3 again. Then use the Variable knob○.
6. To start the program, press F5 or press Auto test/Stop key .
7. To stop the program, press Auto test/Stop key  again.

Range	Cycle (number of repetition)
	1~99
	From: / To: (beginning and end step)
	1~15 From: ≤ To:



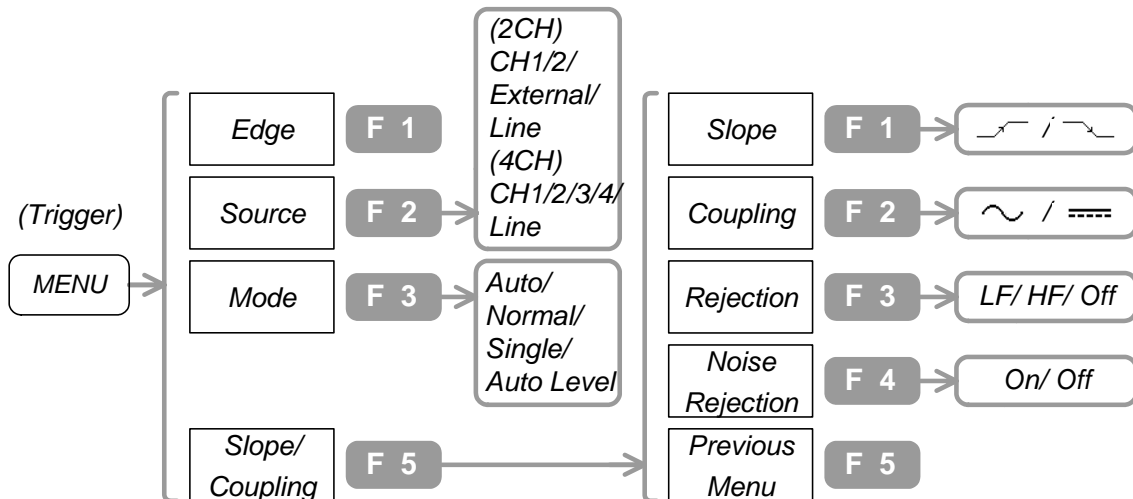

Trigger

Use Edge trigger

Panel operation



1. Press the Trigger menu key. Press F1 repeatedly until “Edge” appears.
2. To select the trigger source signal, press F2 repeatedly.
3. To select the trigger mode, press F3 repeatedly.
4. To select the slope and coupling method, press F5.
5. To select the trigger slope, press F1 repeatedly.
6. To select the trigger coupling, press F2 repeatedly.
7. To select the frequency rejection mode, press F3 repeatedly.
8. To turn On noise rejection, press F4. To turn Off, press again.
9. To go back to the previous menu, press F5.

Range	Trigger source	
	CH1~CH2	Channel1~Channel2 (2CH model)
	CH1~CH4	Channel1~Channel4 (4CH model)
	External	Signal from the External trigger input (only for 2CH model)
	Line	AC Power supply signal
	Trigger mode	
	Auto	GDS-2000 generate an internal trigger if there is no trigger event. Select this mode when viewing rolling waveform at slower timebase, maximum 10s/div.
	Normal	GDS-2000 acquire waveform in a trigger event.
	Single	GDS-2000 acquire waveform only once in a trigger event. Press Run/Stop key to acquire again.
	Auto Level	GDS-2000 automatically adjust the trigger level indicator to the center part of the waveform.
	Slope	
		Rising edge
		Falling edge
	Coupling	
		AC coupling
		DC coupling
	(Frequency) Rejection	
	LF	Low Frequency rejection. Rejects frequency below 50kHz.
	HF	High Frequency rejection. Rejects frequency above 50kHz.
	Off	Rejection disabled
	Noise Rejection	
	ON	Uses DC coupling with low sensitivity to reject noise.
	OFF	Noise rejection disabled

Use Video trigger

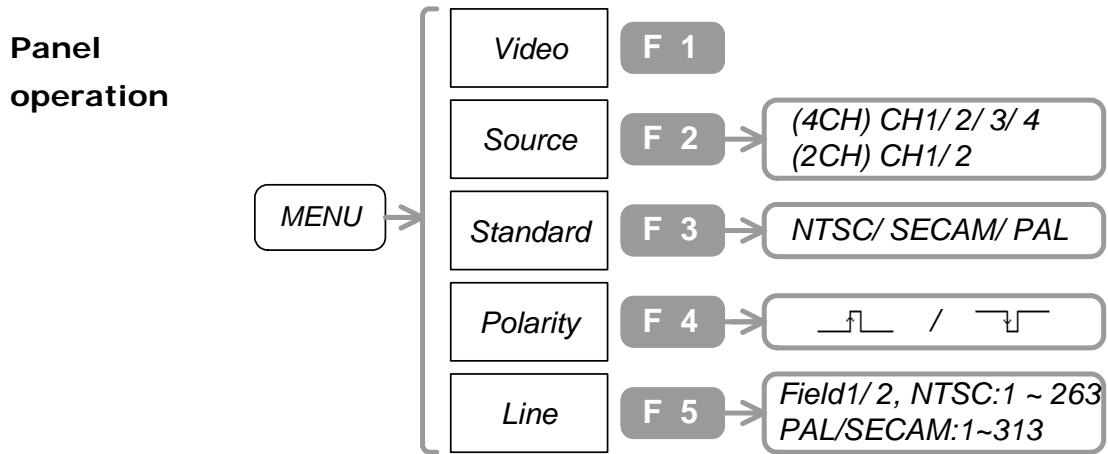

1. Press the Trigger menu key. Press F1 repeatedly until “Video” appears.
2. To select the trigger source signal, press F2 repeatedly.
3. To select the video standard, press F3 repeatedly.
4. To select the trigger polarity, press F4 repeatedly.
5. To select the trigger field line, press F5. Then use the Variable knob .

Range

Trigger source

CH1~2(4) Channel1~Channel2 (Channel4)

Video standard

NTSC National Television System Committee video standard.

PAL Phase Alternative by Line video standard.

SECAM SEquential Couleur A Memoire video standard.

Polarity



Positive pulse



Negative pulse

Video Field



1 ~ 263 For NTSC

1 ~ 313 For PAL/ SECAM

Use Pulse width trigger

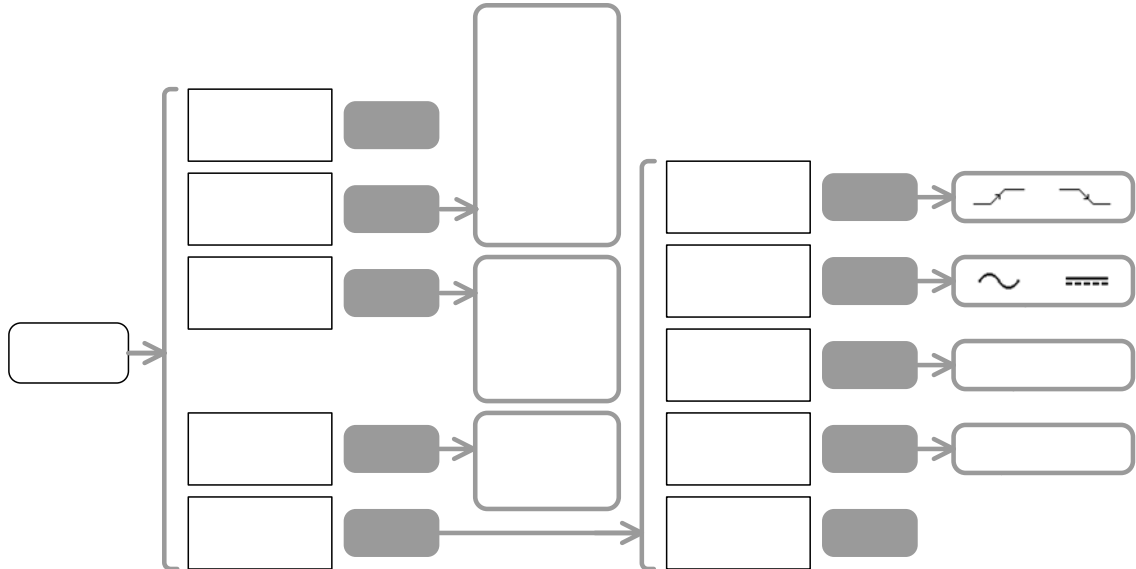
Panel operation



1. Press the Trigger menu key. Press F1 repeatedly until “Pulse” appears.
2. To select the trigger source signal, press F2 repeatedly.
3. To select the trigger mode, press F3 repeatedly.
4. To select the trigger condition, press F4 repeatedly. To set the parameter, use the Variable knob .
5. To select the slope and coupling method, press F5.
6. To select the trigger slope, press F1 repeatedly.
7. To select the trigger coupling, press F2 repeatedly.
8. To select the frequency rejection mode, press F3 repeatedly.
9. To turn On noise rejection, press F4. To turn Off, press again.
10. To go back to the previous menu, press F5.
11. To set the trigger level, use the Trigger knob .

Range

Trigger source

CH1~CH4 Channel1~Channel4

External	External trigger input signal (only for 2CH model)
Line	AC power input

Trigger mode

Auto	GDS-2000 generates an internal trigger if there is no trigger event.
Normal	GDS-2000 acquires waveform in a trigger event.
Single	GDS-2000 acquire waveform only once in a trigger event. Press Run/Stop key to acquire again.
Auto Level	GDS-2000 automatically adjusts the trigger level indicator to the center part of the waveform.

Time compare factor

<	Trigger on pulse width smaller than the time setting
>	Trigger on pulse width larger than the time setting
=	Trigger on pulse width equal to the time setting
≠	Trigger on pulse width different than the time setting

Slope



Trigger on the positive pulse width
 Trigger on the negative pulse width

Coupling



AC coupling
 DC coupling

(Frequency) Rejection

LF	Low Frequency rejection. Rejects frequency below 50kHz.
HF	High Frequency rejection. Rejects frequency above 50kHz.
Off	Rejection disabled

Noise Rejection



On	Uses DC coupling with low sensitivity to reject noise.
Off	Noise rejection disabled

Use Advanced delay trigger

Advanced delay trigger is available only in 2CH models.

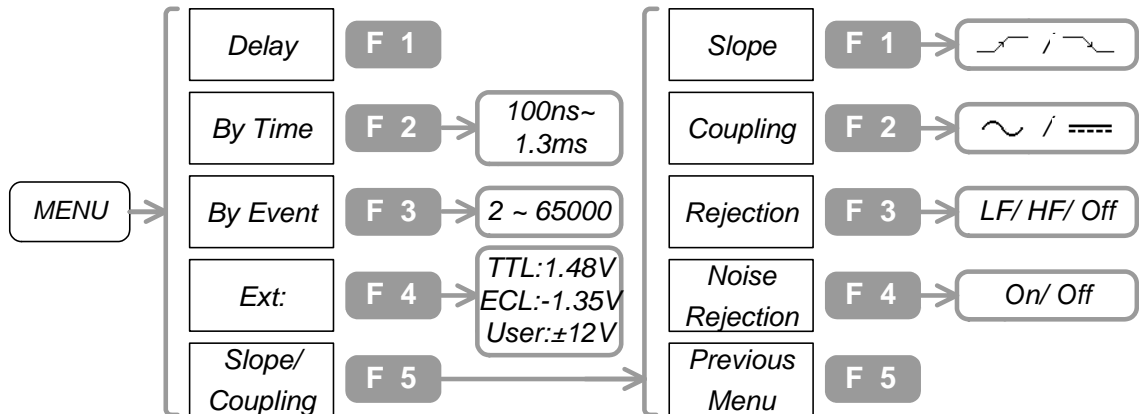
Panel operation



1. Connect the start trigger signal to Channel1, and main signal to Channel2.
2. Press the Trigger menu key→F1. Press F1 until “Delay” appears.
3. To set the delay time, press F2. Then use the Variable knob .
4. To set the number of trigger event, press F3. Then use the Variable knob .
5. To set the triggering level of start signal, press F4 repeatedly. For user level, use the Variable knob .
6. To select the trigger slope, press F5, then press F1 repeatedly.
7. To select the coupling mode, press F2 repeatedly.
8. To select the frequency rejection mode, press F3 repeatedly.
9. To select the noise rejection mode, press F4 repeatedly.

Range **By Time** (Trigger delay time)
 100ns ~ 1.3ms

By Event
 2 ~ 65000

Ext. (Trigger level of the start signal)

TTL	+1.4V
ECL	-1.3V
USER	±12V range user defined level

Slope

	Rising edge
	Falling edge

Coupling

	AC coupling
	DC coupling

(Frequency) Rejection

LF	Low Frequency rejection. Rejects frequency below 50kHz.
HF	High Frequency rejection. Rejects frequency above 50kHz.
Off	Rejection disabled

Noise Rejection

On	Uses DC coupling with low sensitivity to reject noise.
Off	Noise rejection disabled

Example

Triggering occurs only after a pre-defined period of time (T)

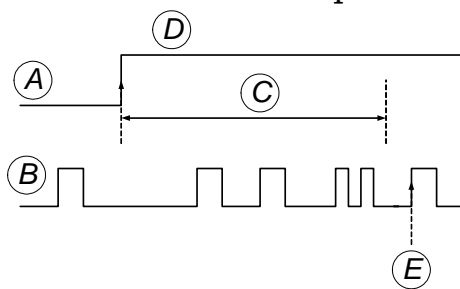

- A: Start Trigger (External)
- B: Main Trigger (CH1 or 2)
- C: Set Time (T)
- D: Trigger
- E: Trigger point

Triggering occurs only after a pre-defined number of user event (three in this case)

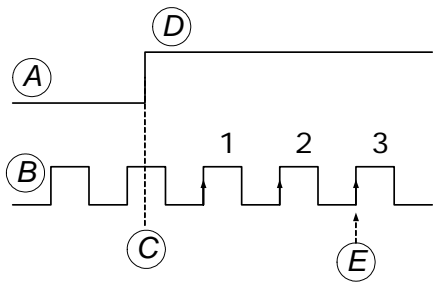

- A: Start Trigger (External)
- B: Main Trigger (CH1 or 2)
- C: Start point of External trigger count
- D: Trigger
- E: Trigger point

Printout/ Data Transfer

Printout	Printout display image	87
	Printout display image (PC software)	88

Save/ Recall	Quick save via USB	89
	Save image/ waveform/ setup	90
	Configure folders and files in USB flash drive	92
	Recall waveform/ setup	94
	Recall default settings	96

Printout

Printout display image (panel operation)

Panel operation

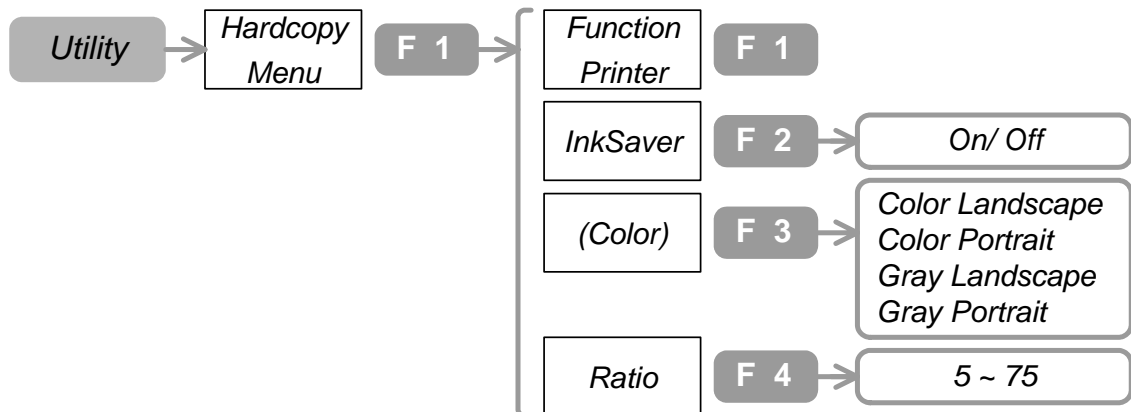

HardCopy

1. Press Utility key→F1. Press F1 repeatedly until “Printer” appears.
2. To select the display background color, press F2 repeatedly.
3. To select the color and portrait, press F3 repeatedly.
4. To select the image size, press F4. Then use the Variable knob.
5. Connect the printer to the front or rear panel USB connector. (Make sure the other USB connector is not used. The two cannot work together at the same time.)

Front panel USB

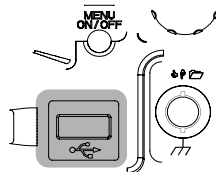

Rear panel USB



6. To start printing, press the Hardcopy key. (GDS-2000 remembers the printout setting. From the next

time, no need to configure the setting unless changed.)

Range InkSaver (Display background color)

On/ Off

InkSaver On

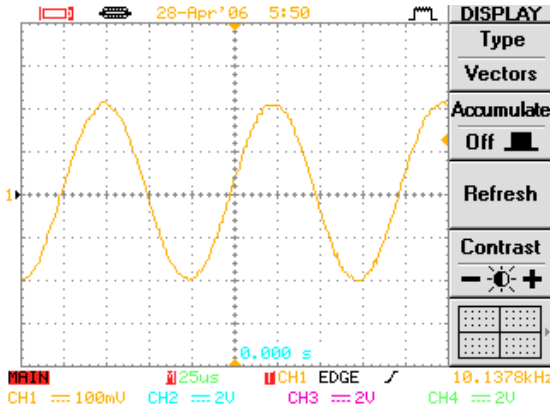

InkSaver Off

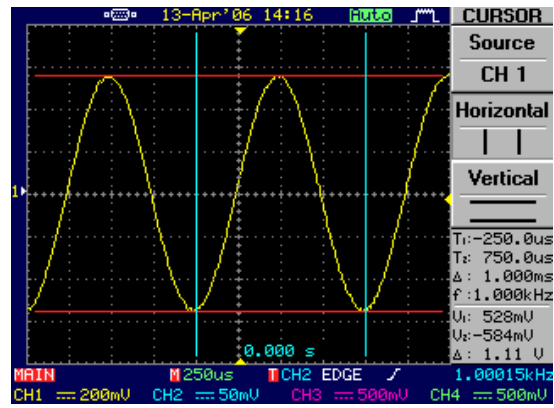

Color/ Portrait

- Color
- Landscape
- Color Portrait
- Gray
- Landscape
- Gray Portrait

Ratio (Image size)

5~75

Confirmed Printers The following printers have been confirmed.
 HP Deskjet 970CXI
 HP LaserJet 1010/ 1015/ 1300
 Epson AL-C8600

Printout display image (PC software)

Use the printout function in the software. In this way, you can print out the image to any printer as long as your PC recognizes it. See page97 for software setup.

Save/ Recall

Quick save via USB flash drive

Panel operation

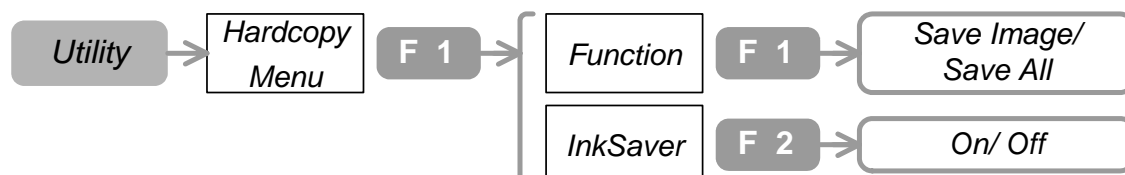

HardCopy

1. Press Utility key→F1.
2. To select the saved information, press F1 repeatedly.
3. To select the display background color, press F2 repeatedly.
4. Connect the USB flash drive to the front or rear panel USB connector. (Make sure the other USB connector is not used. The two cannot work together at the same time.)

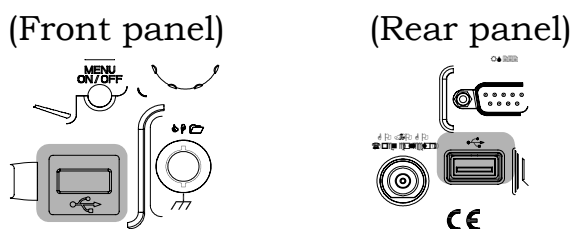



5. To store the information, press the Hardcopy key. (GDS-2000 remembers the printout setting. From the next time, no need to configure the setting unless changed.)

Range	Image	Saves the display image (GWxxxx.BMP).
	All	Saves the following data in a folder (Allxxxx). Display image: Axxx.BMP Waveform: Axxx.CSV Setup: Axxx.SET
	InkSaver (Display background color)	
	On/Off	For an example, see the previous page.

Save image/ waveform/ setup

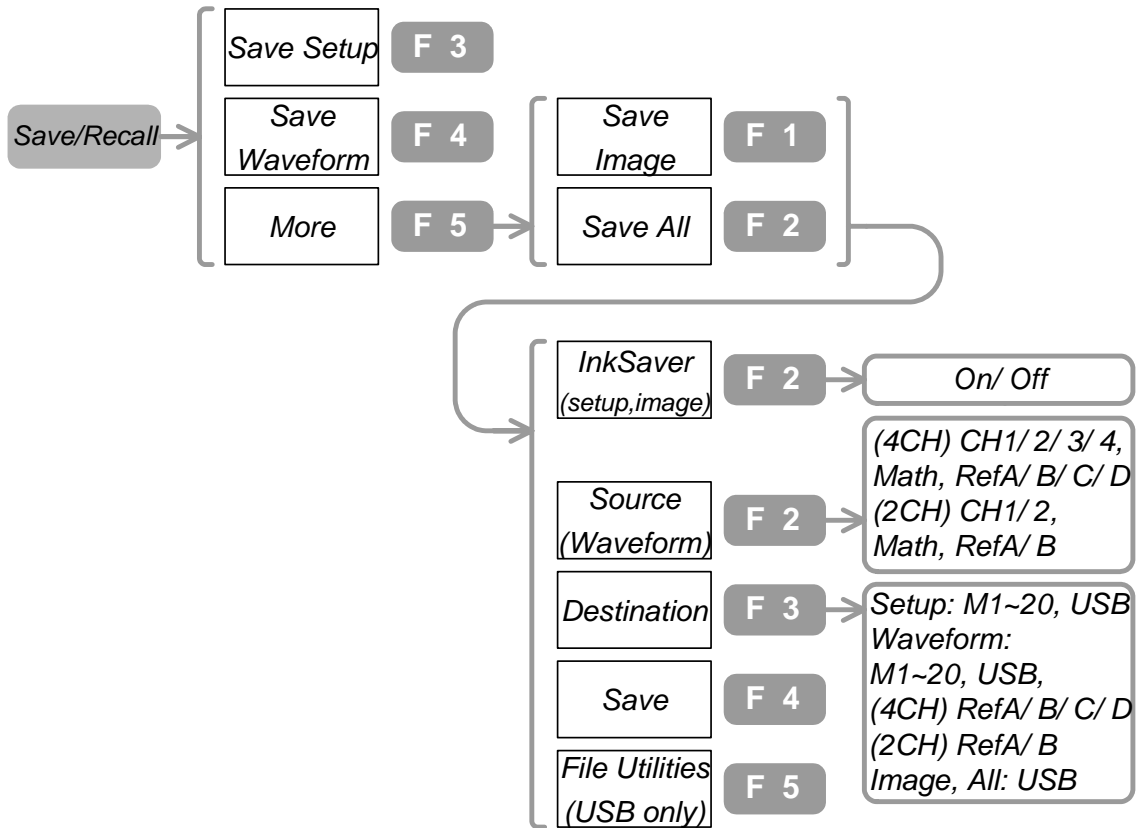
Panel operation



1. Press Save/Recall key→F3 (Setup) or F4 (Waveform) or F5→F1 (Image) or F5→F2 (All).
2. (For Image and All) To select the display background color, press F2 repeatedly.
3. (For Waveform) To select the waveform source, press F2. Then use the Variable knob .
4. To select the location type, press F3 repeatedly. Then use the Variable knob .
5. (Storing to USB flash drive) Connect the USB flash drive to the front or rear panel USB connector. (Make sure the other USB connector is not used. The two cannot work together at the same time.)

Front panel
USB

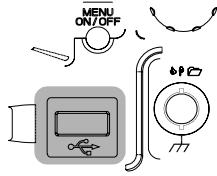

Rear panel
USB

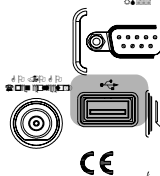

Save dialog screen

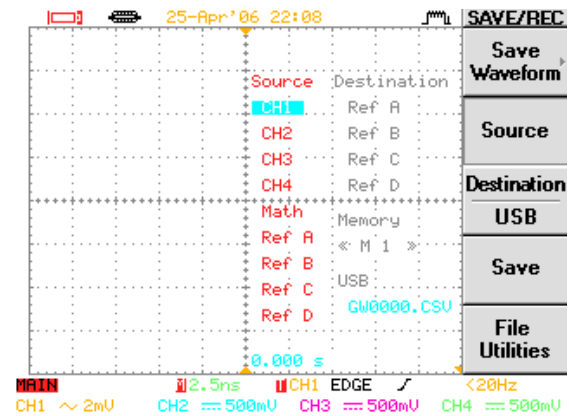

6. To save the file, press F4.

7. To configure USB folders, see page92.

Range

File type

Setup

Setup file (Gxxx.SET).

Waveform

Waveform file (Gxxx.CSV).

Image

Image file (Gxxx.BMP).

All

A folder (Axxx) containing setup (Axxx.SET), waveform (Axxx.CSV), and image file (Axxx.BMP).

InkSaver (Display background color)

On/Off

See page88 for the actual effect.

Source

CH1~CH4

Channel1 ~ Channel4 waveforms

MATH

The waveform generated by math operations (page74).

RefA~D

Reference waveforms A~D

Destination

RefA~D

Reference waveforms A~D

Memory

M1~M20 internal memory.

USB

USB flash drive.

Configure folders and files in USB flash drive

This part assumes you have connected a USB flash drive to GDS-2000 and have already selected F5 “File Utilities” in other save and recall menus.

Panel operation

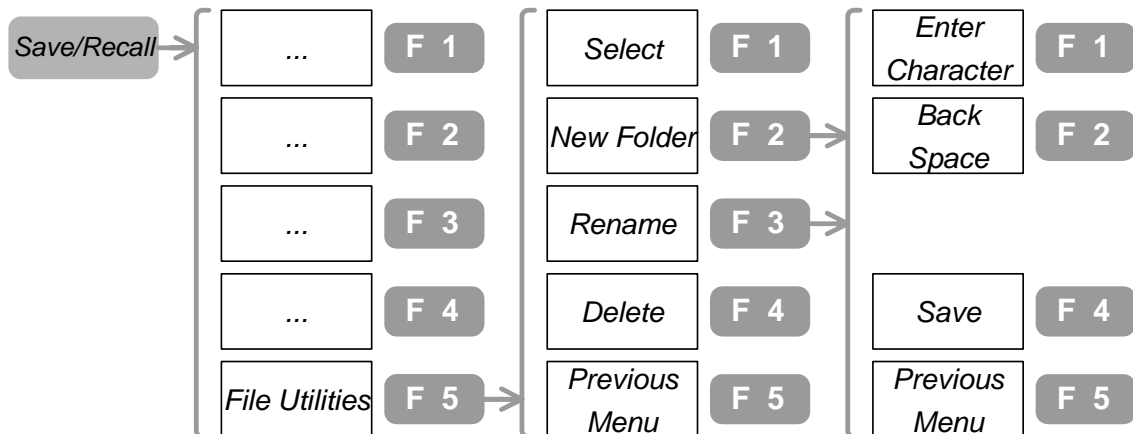

See the folder contents

1. Use the Variable knob  to select the folder.
2. To enter the folder, press F1.
3. To go back to the previous level, select the root and press F1.

Root

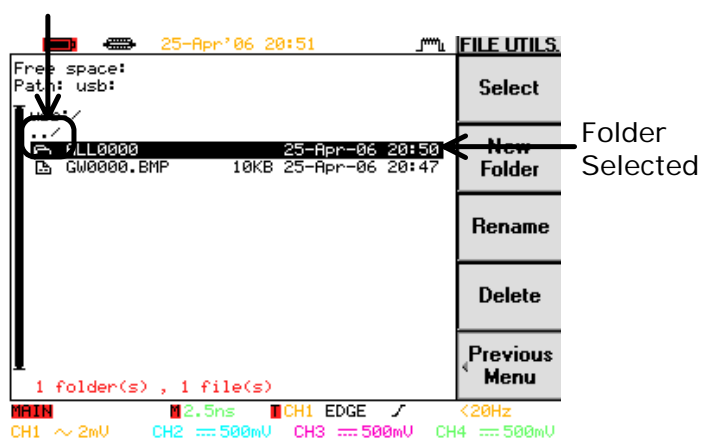

Create a new folder & rename a file/folder

1. Press F2 (new folder) or F3 (rename a file or a folder). The editing screen appears.



2. To enter a character, select the letter using the Variable knob  and press F1.
3. To delete a character, press F2.
4. To save the result, press F4.

Delete a file/folder

1. Use the Variable knob  and move to the file or folder.
2. Press F4. Press again to confirm deletion.

Recall waveform/ setup

Panel operation

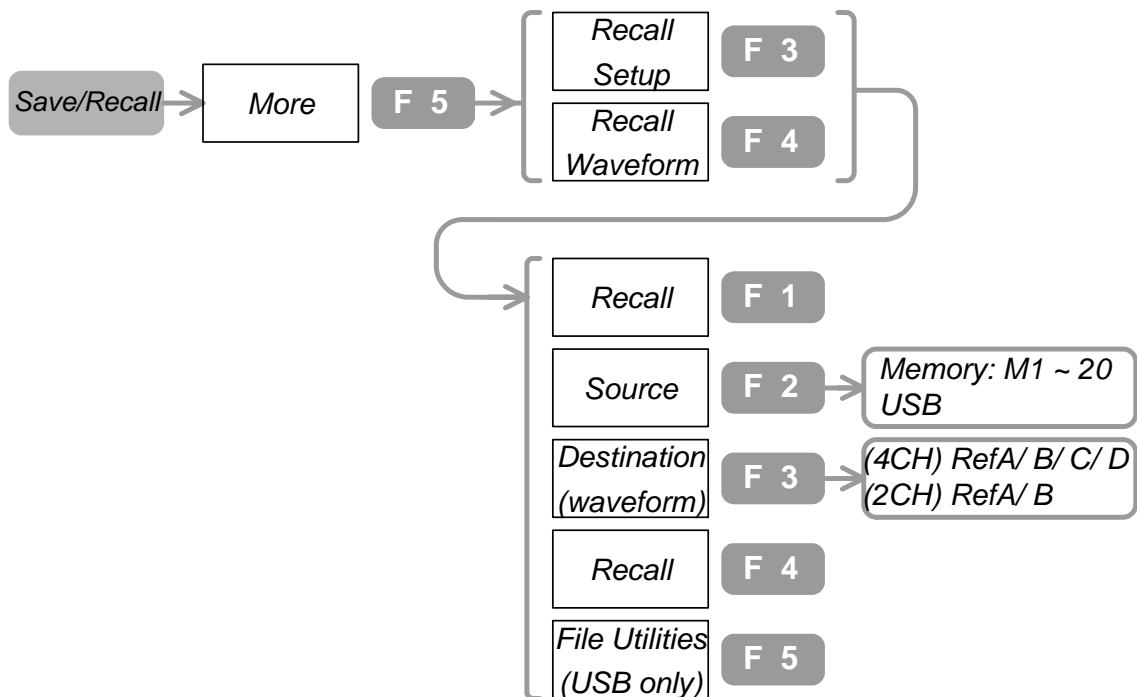

Display the recalled waveform

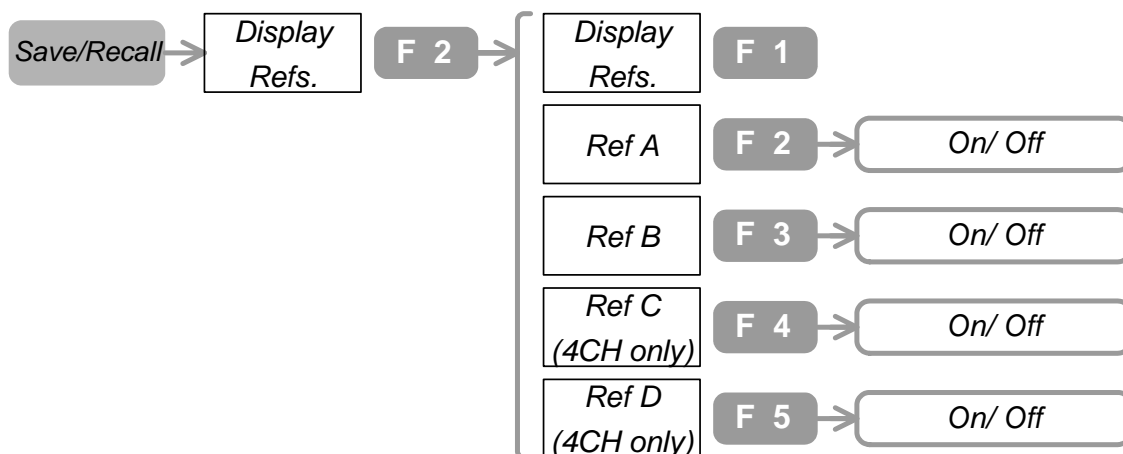

1. Press Save/Recall key→F5→F3 (setup)/ F4 (waveform).
2. To select the source, press F2 repeatedly.
3. To select the memory location, use the Variable knob .
4. (Recalling from USB flash drive) Connect the flash drive to the front or the rear USB connector. (Make sure the other USB

connector is not used. The two cannot work together at the same time.)

Front panel USB

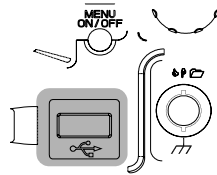

Rear panel USB

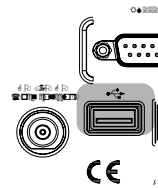

5. (Recalling waveforms) To select the destination (reference waveform), press F3 repeatedly.
6. To recall waveform/setup, press F4.
7. To configure USB folders, see page92.
8. (Showing the recalled waveform) Press Save/Recall key→F2. To show the waveform, select among F2~F4 and press it.

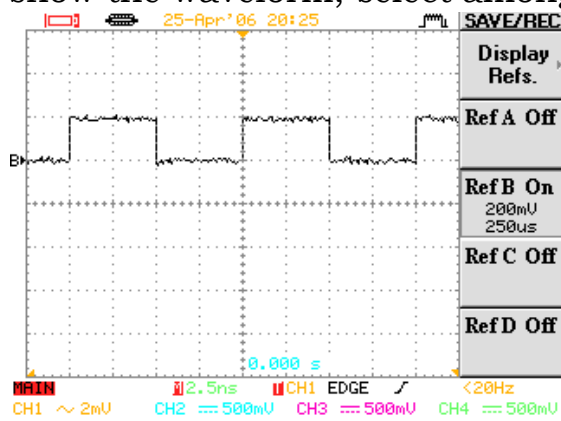

Ref B waveform recalled

Range	File type	
	Waveform	Waveform file (xxxx.CSV).
	Setup	Panel setup file (xxxx.SET).
	Source	
	Memory	M1~M20 internal memories
	USB	USB flash drive (Gxxx.SET)
	Destination	
	Ref A/B/C/D (4CH models)	Reference waveforms stored internally.
	Ref A/B (2CH models)	

Recall default settings

Panel Operation

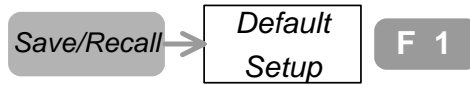

Press Save/Recall key→F1. GDS-2000 recalls the factory installed panel settings, listed below.

Acquisition	Mode: Normal	Memory Length: 500
Channel (Vertical)	Scale: 2V/Div Coupling: DC BW Limit: Off	Invert: Off Probe Attenuation: x1
Cursor	Source: CH1 Vertical: None	Horizontal: None
Display	Type: dots Graticule:	Accumulate: Off
Go-NoGo	Go-NoGo: Off NoGo when:	Source: CH1 Violating: Stop
Horizontal	Scale: 2.5us/Div	Mode: Main Timebase
Math	Type: + Position: 0.00 Div	Channel: CH1+CH2 Unit/Div: 2V
Measure	Source1: CH1 Volt type: VPP Delay type: FRR	Source2: CH2 Time Type: Frequency
Program	Mode: Edit Item: Memory	Step: 1
Trigger	Type: Edge Mode: Auto Coupling: DC Noise Rejection : Off	Source: Channel1 Slope:
Utility	Hardcopy: SaveImage, Inksaver Off Sound: Off	Interface: GPIB, Address 8

Remote Control

Use PC Software	Configure the interface	97
	Download and Install PC Software.....	98
	Setup and use the PC Software.....	99
Use IEEE Based Remote control	Configure the interface	102
	Command Syntax	104
	Command Set	105

Use PC Software

Configure the interface



1. Press the Utility key→F2. To select the interface Press F1 repeatedly.
2. The interface icon appears on the top left side of the display.

Interface Icon

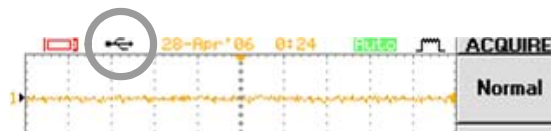

3. Connect the USB cable to the rear panel connector.

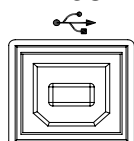

Download and Install PC Software

Software Download the software from GWINSTEK website.

Download

1. Access www.gwinstek.com.tw.
2. Click the Download menu on the left task bar.



3. The Software download screen appears. Select Oscilloscope from the drop down menu.

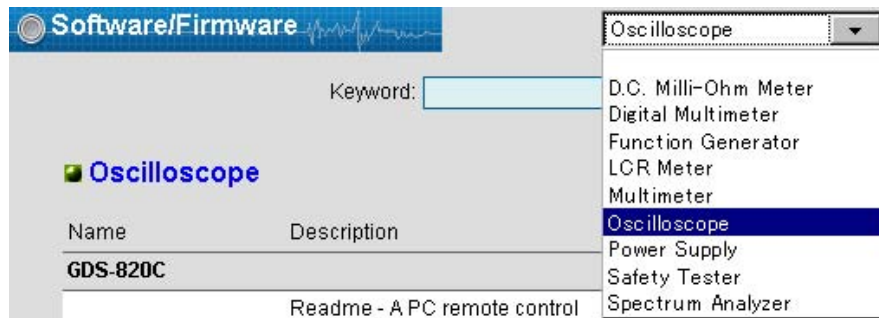

4. Click the PC software name under GDS-2000 section and download the software package to your local PC.

Software 1. Unpack the file.

Installation

2. Follow the instructions in **readme.txt**.

Setup and use the PC Software

Screen Description

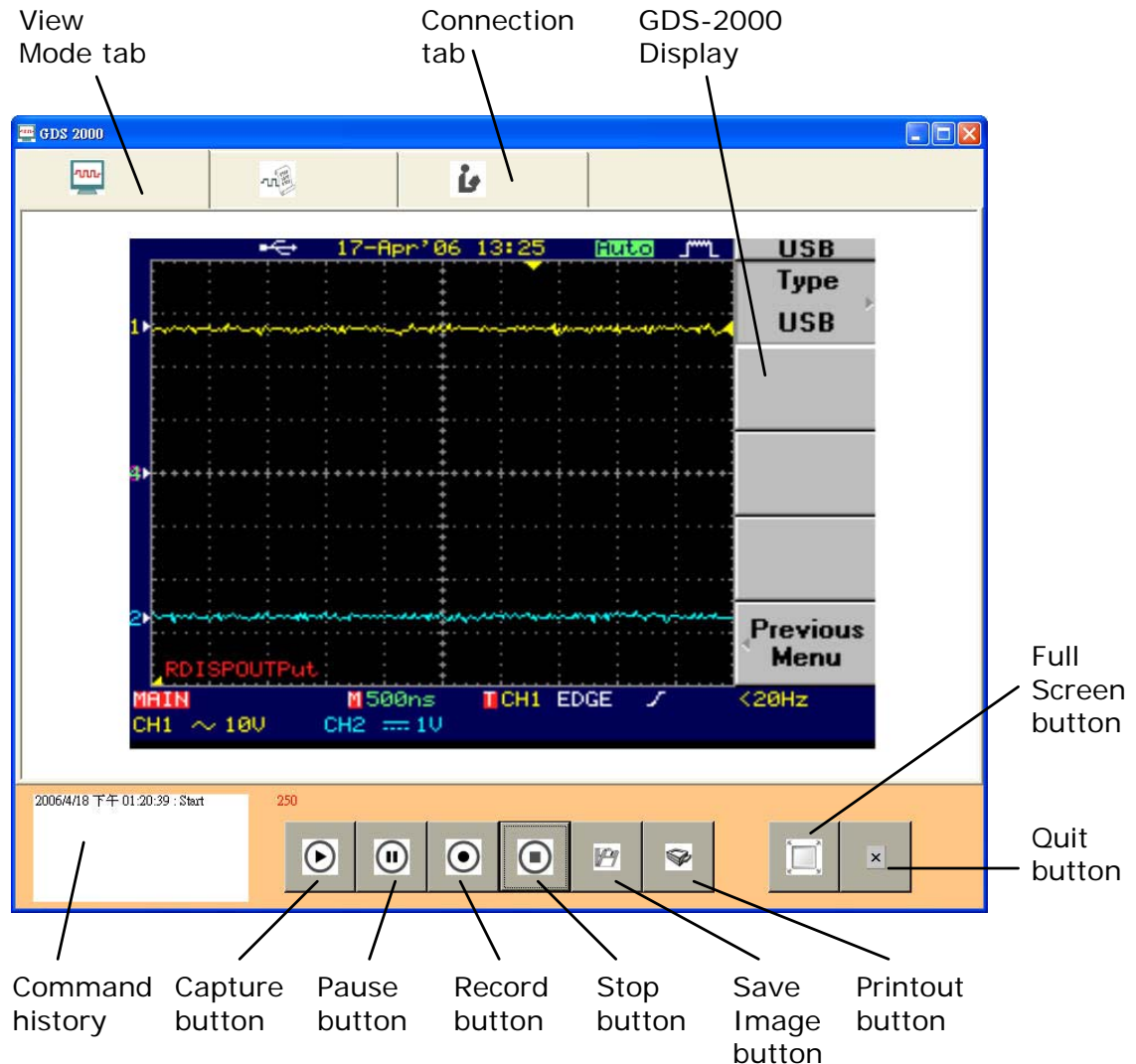

1. Establish the connection

1. Install and activate the software. For details, see page98.
2. Configure and connect USB/RS232C cable. For details, see page97.
3. Click the Connection tab. Then click the Scan button. The oscilloscope ID appears, indicating the connection has been established.

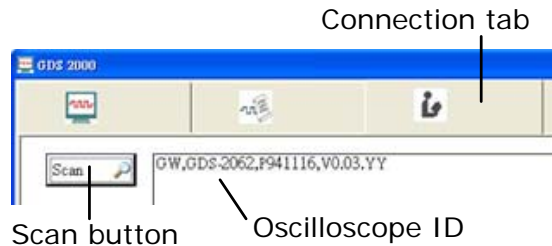

Scan button Oscilloscope ID
 Oscilloscope ID format: (from left)
 Manufacturer, Model No, Serial No, Firmware version

2. Capture the waveform

Click the Play mode tab. Then click the Play button. GDS-2000 display appears on the screen. Command history pane shows the record of issued commands.

Play mode tab

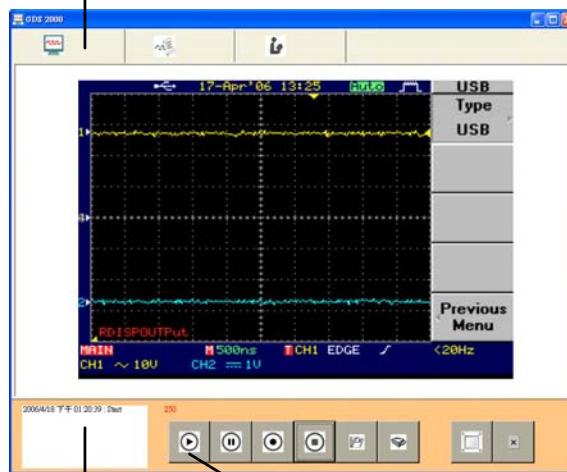

Command history pane Play button

3. Use the applications

Start capturing the display

 Click the play button.

Pause capturing the display (freeze the display)

 Click the pause button.

Record the display video in *.avi format

 Click the record button.

Stop capturing/ recording the display



Click the stop button.

Save the image in *.gif/ *.jpg/ *.png/ *.bmp/ *.tif format



Click the save button. The save file windows appears.

Printout the captured image



Click the print button. The print window appears.

Show the oscilloscope display in full screen



Click the full screen button.

Quit the PC software



Click the quit button. Or...







Close the window directly.

Use IEEE based remote control

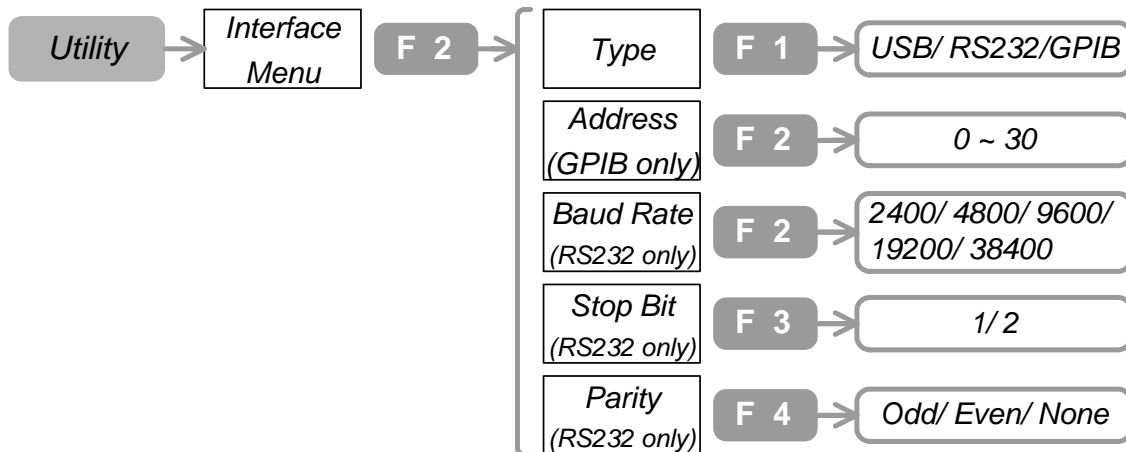
Configure the interface

Panel operation



1. Press the Utility key→F2. To select the interface Press F1 repeatedly.
2. The interface icon appears on the top left side of the display.
 USB: 
 RS232C: 
 GPIB (Optional): 

Interface Icon

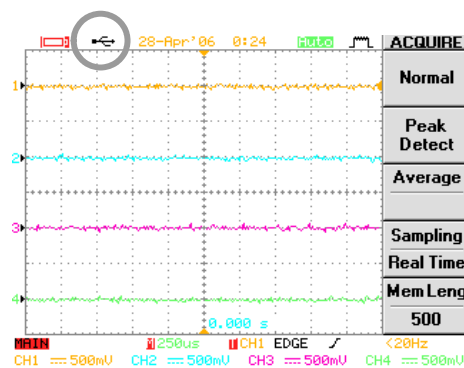

3. (For RS232C only) To configure RS232, press F2 (Baud rate), F3 (Stop Bit), and F4 (Parity) repeatedly.

4. (For GPIB only) To select the address, press F2 repeatedly.
5. Connect the USB/RS232C/ GPIB cable to the rear panel.

USB

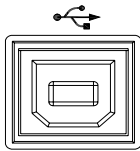

RS-232C

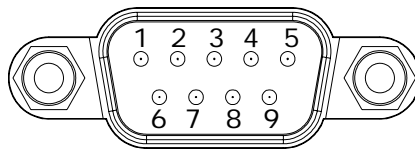

GPIB (Optional)

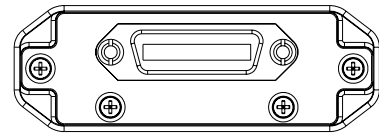

2: RxD, 3: TxD, 5: GND
1, 4, 6~9: No connection

To install, power off the device and plug the GPIB card into the slot.

Functionality Check

Run this query command via a command terminal such as DOS prompt.

*idn?

This should return the Manufacturer, Model number, Serial number, and Firmware version in the following format.

GW, GDS-2064, P920130, V3.01

Range

Baud Rate (RS232C)

2400, 4800, 9600, 19200, 38400

Stop Bit (RS232C)

1, 2

Parity (RS232C)

Odd/ Even/ None

Address (GPIB)

1~30

GPIB Constraints

- Keep these rules when using GPIB interface.
- * Altogether less than 15 devices & 20m cable length, 2m between each device on the bus
 - * Unique address assigned for each device
 - * At least 2/3 of the GPIB devices turned On
 - * No loop or parallel structure allowed

Command Syntax

The commands are fully compatible with IEEE488.2 (1992) standard and partially compatible with SCPI (1994) standard.

Example command



- 1: Command Header
- 2: Single space
- 3: Parameter
- 4: Message Terminator OR Message Separator

Command Header

Several command header elements (nodes) can be concatenated to form a complex command. The above example can be separated into: TRIGger: (root node) + DELay: + MODE:

Parameter example

- <0/1> 0 or 1.
- <1~4> Integer between 1, 2, 3, or 4.
- <0.01~5> Decimal number between 0.01 and 5.
- <1e-9~5> Floating number between 1e-9 and 5.
- < f > Floating number without range.

Message Terminator

Marks the end of a command line. Any of the following is acceptable, in accordance with IEEE488.2 standard.

- LF^END Line feed code (hexadecimal 0A) with END message
- LF Line feed code
- <dab>^END Last data byte with END message

Message Separator

; (semicolon) Command separator.

trig

Command Set

Commands are **non**-case sensitive.

For more detailed information, refer to the Programming Manu

Acquisition

:acq:aver?	Returns the average number of waveform acquisition (available only for average mode).
:acq:aver <2~256>	Sets the average number of waveform acquisition (available only for average mode). Range: 2, 4, 8, 16, 32, 64, 128, 256
:acq:leng?	Returns the memory length. Range: 0 (500), 1 (5000), 2 (12500), 3 (25000)
:acq:leng <0~3>	Sets the memory length. Range: 0 (500), 1 (5000), 2 (12500), 3 (25000)
:acq:mod?	Returns the acquisition mode. Range: 0 (sample), 1 (peak detection), 2 (average)
:acq:mod <0~2>	Sets the acquisition mode. Range: 0 (sample), 1 (peak detection), 2 (average)
:acq<1~4>:mem ?	Returns the whole waveform data for each channel. Format: #, data size, sample rate, channel, data. (select memory length in advance)
:acq<1~4>:poin	Returns the displayed range of waveform data (500 points) for each channel. Format: #, data size, horizontal scale, channel, waveform data.

Automatic measurements

:aut	Setup the horizontal, vertical, and trigger condition automatically (same as Auto Set functionality)
:meas:fall?	Returns the first falling edge timing. (select the channel first)
:meas:freq?	Returns the frequency. (select the channel first)
:meas:nwid?	Returns the first negative pulse width timing. (select the channel first)
:meas:pdut?	Returns the positive pulse width ratio. (select the channel first) Range: 1~99 (in terms of percentage)
:meas:per?	Returns the period value. (select the channel first)
:meas:pwid?	Returns the positive pulse width. (select the

	channel first)
:meas:ris?	Returns the first pulse rising edge timing. (select the channel first)
:meas:sour <1~4>	Sets the measurement channel. Range: 1~4 (Channel1~Channel4)
:meas:vamp?	Returns the voltage difference between positive and negative peak. (select the channel first)
:meas:vav?	Returns the average voltage. (select the channel first)
:meas:vhi?	Returns the global high voltage. (select the channel first)
:meas:vlo?	Returns the global low voltage. (select the channel first)
:meas:vmax?	Returns the maximum amplitude. (select the channel first)
:meas:vmin?	Returns the minimum amplitude. (select the channel first)
:meas:vpp?	Returns the difference between maximum and minimum amplitude. (select the channel first)
:meas:vrms?	Returns the root mean square voltage. (select the channel first)

Cursor

:curs:x<1/2>p?	Returns the horizontal cursor position. Range: 1~249
:curs:x<1/2>p <1~249>	Sets the horizontal cursor position. Range: 1~249
:curs:x<1/2>p?	Returns the vertical cursor position. Range: 1~199
:curs:x<1/2>p <1~199>	Sets the vertical cursor position. Range: 1~199
:curs:xdel?	Returns the difference between two horizontal cursors. Range: 0.001~249
:curs:ydel?	Returns the difference between two vertical cursors. Range: 0.001~199
:curs:xdis <0/1>	Enables or disables horizontal cursor. Range: 0 (disable), 1 (enable)
:curs:ydis <0/1>	Enables or disables vertical cursor. Range: 0 (disable), 1 (enable)
:curs:sour?	Returns the source of the currently active cursor. Range: 1~4 (channel1~4), 5 (math)

:curs:sour <1~5>	Sets the source of the currently active cursor. Range: 1~4 (channel1~4), 5 (math)
---------------------	--

Display

:refr	Refreshes the display contents.
:run	Runs the trigger (unfreezes the waveform).
:stop	Stops the trigger (freezes the waveform).
:disp:acc?	Returns the display accumulation status. Range: 0 (disabled), 1 (enabled)
:disp:acc <0/1>	Enables or disables the display accumulation. Range: 0 (disabled), 1 (enabled)
:disp:cont?	Returns the display contrast level. Range: 0~20 (5% step)
:disp:cont <0~20>	Sets the display contrast level. Range: 0~20 (5% step)
:disp:grat?	Returns the display graticule type. Range: 0 (full grid), 1 (X and Y axis), 2 (no grid)
:disp:grat <0~2>	Sets the display graticule type. Range: 0 (full grid), 1 (X and Y axis), 2 (no grid)
:disp:wav?	Returns the waveform drawing style. Range: 0 (vectors), 1 (dots)
:disp:wav <0/1>	Sets the waveform drawing style. Range: 0 (vectors), 1 (dots)

Go-No Go test

:gon:cle	Clears the Go-No Go test total number/ failure number counter on the display.
:gon:exe <0/1>	Starts or stops Go-No Go test. Range: 0 (stop), 1 (start)
:gon:func?	Returns Go-No Go test status. Range: 0 (disabled), 1 (enabled)
:gon:func <0/1>	Enables or disables Range: 0 (disabled), 1 (enabled)
:gon:ngc?	Returns the Go-No Go test total test count and fail count.
:gon:ngd?	Returns the No Go condition. Range: 0 (No Go when template is not violated), 1 (No Go when template is violated)
:gon:ngd <0/1>	Sets the No Go condition. Range: 0 (No Go when template is not violated), 1 (No Go when template is violated)
:gon:sour?	Returns the Go-No Go test source channel. Range: 0 (channel1), 1 (channel2)

:gon:sour <0/1>	Sets the Go-No Go test source channel. Range: 0 (channel1), 1 (channel2)
:gon:viol?	Returns the Go-No Go violation action. Range: 0 (stop), 1 (stop + buzzer), 2 (continue), 3 (continue + buzzer)
:gon:viol <0~3>	Sets the Go-No Go violation action. Range: 0 (stop), 1 (stop + buzzer), 2 (continue), 3 (continue + buzzer)
:temp<1~100>: down?	Returns the Go-No Go template data. Range: 1~100
:temp<1~100>: upl	Uploads the Go-No Go template data. Range: 1~100
:temp:max?	Returns the Go-No Go Max template number.
:temp:max <1~100>	Sets the Go-No Go Max template number.
:temp:min?	Returns the Go-No Go Min template number.
:temp:min <1~100>	Sets the Go-No Go Min template number.
:temp:mod?	Returns Go-No Go test template mode. Range: 0 (Max or Min), 1 (Auto template)
:temp:mod <0/1>	Sets the Go-No Go test template mode. Range: 0 (Max or Min), 1 (Auto template)
:temp:pos:max?	Returns the Go-No Go test Max template position. Range: -300~300 (= -12~+12div, 1div=25dots)
:temp:pos:max <-300~300>	Sets the Go-No Go test Max template position. Range: -300~300 (= -12~+12div, 1div=25dots)
:temp:pos:min?	Returns the Go-No Go test Max template position. Range: -300~300 (= -12~+12div, 1div=25dots)
:temp:pos:min <-300~300>	Sets the Go-No Go test Max template position. Range: -300~300 (= -12~+12div, 1div=25dots)
:temp:tol?	Returns the Go-No Go test Auto template tolerance. Range: 0.4~40 (percentage)
:temp:tol <0.4~40>	Sets the Go-No Go test Auto template tolerance. Range: 0.4~40 (percentage)

Horizontal scale

:tim:del?	Returns the horizontal delay.
:tim:del < f >	Sets the horizontal delay.
:tim:scal?	Returns the horizontal timebase (Tim/Div). Range: 1e-9~10 (seconds)
:tim:scal	Sets the horizontal timebase (Tim/Div).

<1e-9~10>	Range: 1e-9~10 (seconds)
:tim:swe?	Returns the horizontal sweep mode. Range: 0 (main timebase), 1 (window), 2 (window zoom), 3 (roll), 4 (XY)
:tim:swe <0~4>	Sets the horizontal sweep mode. Range: 0 (main timebase), 1 (window), 2 (window zoom), 3 (roll), 4 (XY)
:tim:wind:del?	Returns the position of the zoomed area.
:tim:wind:del <f >	Sets the position of the zoomed area.
:tim:wind:scal?	Returns the length of the zoomed area.
:tim:wind:scal <f >	Sets the length of the zoomed area.

Printout and data transfer

:prin	Printout the display contents.
:wmem<1/2>:disp?	Returns the waveform display status after being saved: wmem1 (RefA), wmem2 (RefB). Range: 0 (disabled), 1 (enabled)
:wmem<1/2>:disp <0/1>	Enables or disables displaying the waveform after being saved: wmem1 (RefA), wmem2 (RefB). Range: 0 (disabled), 1 (enabled)
:wmem<1/2>:eras	Erases the waveform after being saved. Range: wmem1 (RefA), wmem2 (RefB).
:wmem<1/2>:loc <-200~200>	Sets the position of the stored waveform: wmem1 (RefA), wmem2 (RefB). Range: -200~200
:wmem<1/2>:ofs <-100~100>	Sets the offset of the stored waveform: wmem1 (RefA), wmem2 (RefB). Range: -100~100
:wmem<1/2>:save <0~4>	Saves the waveform: wmem1 (RefA), wmem2 (RefB). Range: 0~3 (channel1~channel4), 4 (math)

Trigger

:trig:coup?	Returns the trigger coupling mode. Range: 0 (AC coupling), 1 (DC coupling)
:trig:coup <0/1>	Sets the trigger coupling mode. Range: 0 (AC coupling), 1 (DC coupling)
:trig:del:tim?	Returns the user-defined trigger delay time. Range: 1e-7~1.3e-3
:trig:del:tim <1e-7~1.3e-3>	Sets the user-defined trigger delay time. Range: 1e-7~1.3e-3

:trig:del:even?	Returns the user-defined trigger delay event count. Range: 2~65000
:trig:del:even <2~65000>	Sets the user-defined trigger delay event count. Range: 2~65000
:trig:del:lev?	Returns the user-defined trigger signal level. Range: -12~12
:trig:del:lev <-12~12 (f) >	Sets the user-defined trigger signal level. Range: -12~12 (floating point)
:trig:del:mod?	Returns the trigger signal level. Range: 0 (TTL), 1 (ECL), 2 (USR)
:trig:del:mod <0~2>	Sets the trigger signal level. Range: 0 (TTL), 1 (ECL), 2 (USR)
:trig:del:typ?	Returns the delay trigger mode. Range: 0 (time driven), 1 (event driven)
:trig:del:typ <0/1>	Sets the delay trigger mode. Range: 0 (time driven), 1 (event driven)
:trig:freq?	Returns the trigger frequency.
:trig:lev?	Returns the trigger level.
:trig:lev < >	Sets the trigger level.
:trig:mod?	Returns the trigger mode. Range: 0 (auto level), 1 (auto), 2 (normal), 3 (single)
:trig:mod <0~3>	Sets the trigger mode. Range: 0 (auto level), 1 (auto), 2 (normal), 3 (single)
:trig:nrej?	Returns the trigger noise rejection status. Range: 0 (disabled), 1 (enabled)
:trig:nrej <0/1>	Sets the trigger noise rejection status. Range: 0 (disabled), 1 (enabled)
:trig:puls:mod?	Returns the pulse trigger mode. Range: 0 (<), 1 (>), 2 (=), 3 (≠)
:trig:puls:mod <0~3>	Sets the pulse trigger mode. Range: 0 (<), 1 (>), 2 (=), 3 (≠)
:trig:puls:tim?	Returns the trigger pulse width time.
:trig:puls:tim < f >	Sets the trigger pulse width time.
:trig:rej?	Returns the trigger frequency reject status. Range: 0 (disabled), 1 (low frequency rejected), 2 (high frequency rejected)
:trig:rej <0~2>	Sets the trigger frequency reject status. Range: 0 (disabled), 1 (low frequency rejected), 2 (high frequency rejected)
:trig:slop?	Returns the trigger slope type. Range: 0 (rising edge), 1 (falling edge)

:trig:slop <0/1>	Sets the trigger slope type. Range: 0 (rising edge), 1 (falling edge)
:trig:sour?	Returns the trigger source. Range: 0~3 (channel1~4), 4 (external), 5(line)
:trig:sour <0~5>	Sets the trigger source. Range: 0~3 (channel1~4), 4 (external), 5(line)
:trig:typ?	Returns the trigger type. Range: 0 (edge), 1 (video), 2 (pulse), 3 (delay)
:trig:typ <0~3>	Sets the trigger type. Range: 0 (edge), 1 (video), 2 (pulse), 3 (delay)
:trig:vid:fiel?	Returns the video trigger field. Range: 0 (line), 1 (field1), 2 (field2)
:trig:vid:fiel <0~2>	Sets the video trigger field. Range: 0 (line), 1 (field1), 2 (field2)
:trig:vid:lin?	Returns the video trigger line. Range: 1~263 (NTSC), 1~313 (SECAM, PAL)
:trig:vid:lin <1~263 (313)>	Sets the video trigger line. Range: 1~263 (NTSC), 1~313 (SECAM, PAL)
:trig:vid:pol?	Returns the video trigger polarity. Range: 0 (positive), 1 (negative)
:trig:vid:pol <0/1>	Sets the video trigger polarity. Range: 0 (positive), 1 (negative)
:trig:vid:typ?	Returns the video trigger TV system. Range: 0 (PAL), 1 (NTSC), 2 (SECAM)
:trig:vid:typ <0~2>	Sets the video trigger TV system. Range: 0 (PAL), 1 (NTSC), 2 (SECAM)

Verical scale, Math

:chan<1~4>:bwl ?	Returns the bandwidth limit status for each channel. Range: 0 (limit Off), 1 (limit On)
:chan<1~4>:bwl <0~1>	Enables/disables the bandwidth limit for each channel. Range: 0 (limit Off), 1 (limit On)
:chan<1~4>:cou p?	Returns the coupling mode for each channel. Range: 0 (AC coupling), 1 (DC coupling), 2 (Ground coupling)
:chan<1~4>:cou p <0~2>	Sets the coupling mode for each channel. Range: 0 (AC coupling), 1 (DC coupling), 2 (Ground coupling)
:chan<1~4>:dis p?	Returns the active status for each channel. Range: 0 (disabled), 1 (enabled)
:chan<1~4>:dis p <0~1>	Enables or disables each channel. Range: 0 (disabled), 1 (enabled)

:chan<1~4>:inv ?	Returns the invert status for each channel. Range: 0 (no change), 1 (inverted)
:chan<1~4>:inv <0~1>	Inverts each channel. Range: 0 (no change), 1 (inverted)
:chan<1~4>:math <0~3>	Sets the math operation for each channel. Range: 0 (Add), 1 (Subtract), 2 (Multiplication), 3 (Division), 4 (FFT), 5 (Off)
:chan<1~4>:offset ?	Returns the offset voltage (Volt) for each channel. Range: 0.001~5
:chan<1~4>:offset <0.001~5>	Sets the offset voltage (Volt) for each channel. Range: 0.001~5 (depends on scale)
:chan<1~4>:prob ?	Returns the probe attenuation factor for each channel. Range: 0 (x1), 1 (x10), 2 (x100)
:chan<1~4>:prob <0~2>	Sets the probe attenuation factor for each channel. Range: 0 (x1), 1 (x10), 2 (x100)
:chan<1~4>:scale ?	Returns the vertical scale (Volt/Div) for each channel. Range: 0.002~5
:chan<1~4>:scale <0.002~5>	Sets the vertical scale (Volt/Div) for each channel. Range: 0.002~5

Registers manipulation

*cls	Clears all event status registers (Output Queue, Operation Event Status, Questionable Event Status, Standard Event Status)
*ese?	Returns the ESER (Event Status Enable Register) contents. Example: 130→means ESER=10000010
*ese <0~255>	Sets the ESER contents. Example: *ese 65→sets ESER to 01000001
*esr?	Returns and clears the SESR (Standard Event Status Register) contents. Example: 198→means SESR=11000110
*idn?	Returns the oscilloscope ID as Manufacturer, Model No, Serial No, Firmware version. Example: GW, GDS-2064, P920130, V3.01
*lrm?	Returns the oscilloscope settings as strings.
*opc?	“1” is placed in the output queue when all the pending operations are completed.
*opc	Sets the operation complete bit (bit0) in SERS

	(Standard Event Status Register) when all the pending operations are completed.
*rcl <1~15>	Recalls the panel setup from internal memory. Example: *RCL 1→recalls setup from memory1
*rst	Recalls the default panel setup (reset the device).
*sav <1~15>	Saves the panel setup to internal memory. Example: *SAV 1→saves setup to memory1
*sre?	Returns the SRER (Service Request Enable Register) contents. Example: 3→means SRER=00000011
*sre <0~255>	Sets the SRER contents. Example: *SRE 7→SRER=00000111
*stb?	Returns the SBR (Status Byte Register) contents. Example: 81→means SBR=01010001
*wai	Prevents execution of further commands until all the pending operations are completed.

Calibration

Calibrate the vertical scale

*Run Calibration under two conditions.

1 When using GDS-2000 in a new environment, such as field measurement.

2 When the temperature changes more than 5°C.

* Trigger Level and Delay Time calibration are available only for the service personnel.

Panel operation

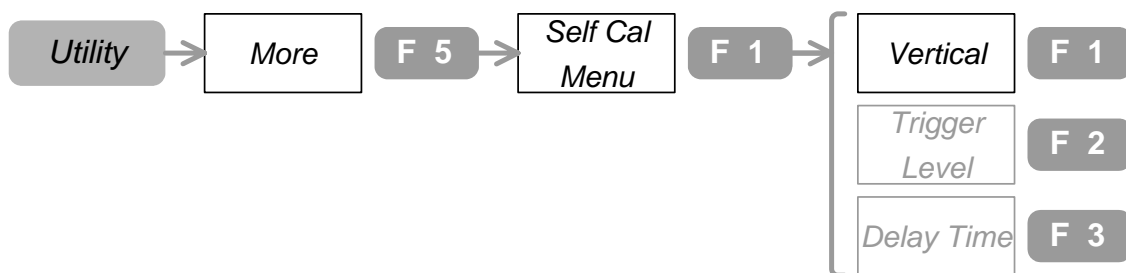

1. Make sure the environment fits these conditions.
Temperature: $26 \pm 5^{\circ}\text{C}$, Relative humidity: $\leq 80\%$
2. Connect the rear panel Calibration output to Channel1. (BNC male – male connector)

Calibration Output



Connect to Channel1

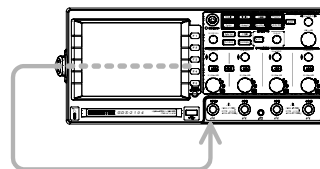

3. Press the Utility key→F5→F1.
4. Press F1, which calibrates the vertical scale.
5. Press F5 and start the calibration (approx. 2 minutes).
6. When completed, switch the connection to channel 2. Repeat the above process for the whole channel.

Compensate the probe

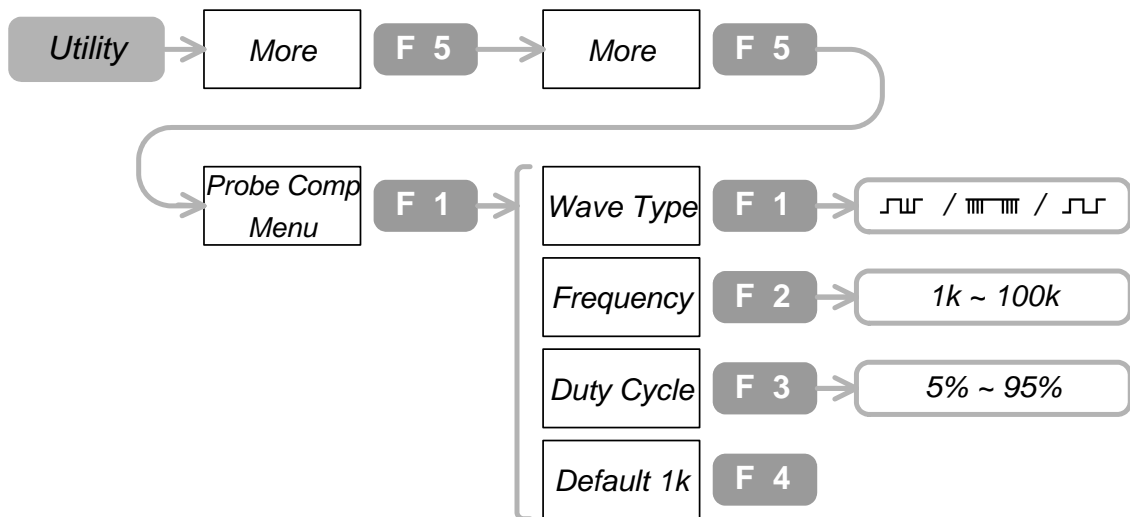

Run probe compensation when using it for the first time.

Panel operation



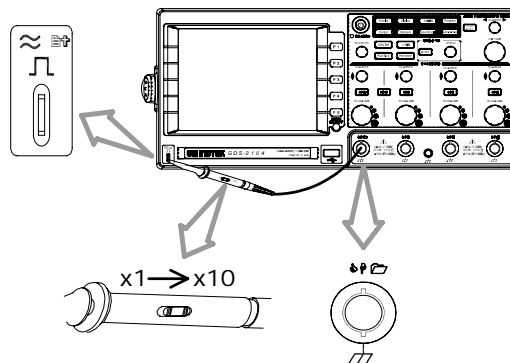

1. Connect the probe to Channel1 and reference signal output.

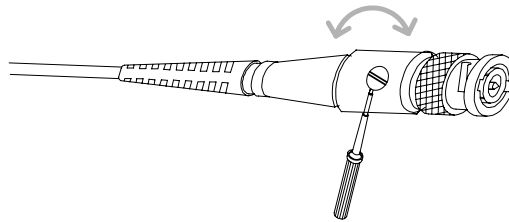
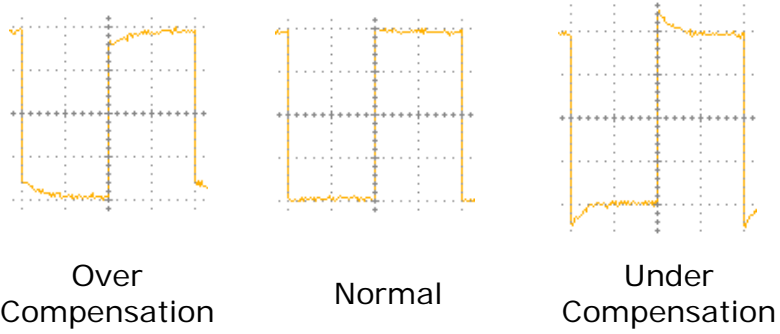

2. Press Utility key→F5→F5→F1→F1. Press F1 again and select the wave type $\lrcorner\lrcorner$.
3. Press F2. Use Variable knob  and set the frequency.
4. Press F3. Use Variable knob  and set the Duty cycle.
5. Compensate the probe viewing the waveform shape.



Range	Wave type	
		Probe compensation signal, 2Vpp at x10 probe attenuation.
		Demonstration signal for showing the effects of deep memory length.
		Demonstration signal for showing the effects of peak detection.
	Frequency	
	1k~100k	1k step.
	Duty Cycle	
	5%~95%	5% step.

FAQ

- I pressed the Power (On/Standby) key on the front panel but nothing happens.
 - The probe waveform is distorted.
 - I connected the signal but it does not appear on screen.
 - Autoset does not catch the signal well.
 - I want to clean up the cluttered panel settings.
 - The display image printout is too dark on the background.
 - I want to install the optional battery pack. I put the battery pack in but it is not working.
 - The date and time setting is not correct.
 - USB does not work.
 - The accuracy does not match the specification.
-

I pressed the Power (On/Standby) key on the front panel but nothing happens.

Make sure you turned on the rear panel Power switch. For details, see page 14.

Note that after proper sequence, it takes around 15~20 seconds for the display to become active.

The probe waveform is distorted.

You might need to compensate the probe. For details, see page 15. Note that the frequency accuracy and duty factor are not specified for probe compensation waveform and therefore it should not be used for other reference purpose.

I connected the signal but it does not appear on screen.

Make sure you have activated the channel by pressing the channel key  (the LED lights).

Autoset does not catch the signal well.

Autoset function cannot catch signals under 30mV or 30Hz. Please use the manual operation.

I want to clean up the cluttered panel settings.

Recall the default settings by pressing Save/Recall key→F1. For details, see page96.

The display image printout is too dark on the background.

Use the Inksaver function: it reverses the display background and waveform color. For details, see page87, 89.

I want to install the optional battery pack.

I put the battery pack in but it is not working.

The battery pack needs additional internal components to work properly. They are factory installed items: contact your dealer.

The date and time setting is not correct.

For setting them, please see page61. If it does not help, the internal battery controlling the clock might be worn out. Contact your service dealer or GWInstek.

USB does not work.

Make sure you are not using the front and the rear USB connector at the same time. Disconnect either of the USB device and try again.

The accuracy does not match the specification.

Make sure the device is powered on for at least 30 minutes, within +20°C~+30°C, which is necessary to stabilize the unit to match the specification.

Appendix

Specifications

The specifications apply under the following conditions: GDS-2000 is powered on for at least 30 minutes, within +20°C~+30°C.

	GDS-2062/64	GDS-2102/04	GDS-2202/04
Channels	2/4	2/4	2/4
Bandwidth	DC~60MHz (-3dB)	DC~100MHz (-3dB)	DC~200MHz (-3dB)
Rise Time	5.8ns approx.	3.5ns approx.	1.75ns approx.

GDS-2062/2064/2102/2104/2202/2204

Vertical	Sensitivity	2mV/div~5V/Div (1-2-5 increments)
	Accuracy	± (3% x Readout + 0.05div x Volts/div)
	Input Coupling	AC, DC, & Ground
	Input Impedance	1MΩ±2%, ~16pF
	Polarity	Normal & Invert
	Maximum Input	300V (DC+AC peak), CATII
	Waveform Signal Process	+, -, x, ÷, FFT
	Offset Range	2mV/div~20mV/div: ±0.5V 50mV/div~200mV/div: ±5V 500mV/div~2V/div: ±50V 5V/div: ±300V
	Bandwidth Limit	20MHz (-3dB)
	Trigger	Sources
Modes		Auto-Level, Auto, Normal, Single, TV, Edge, Pulse Width, Time-Delay, Event-Delay(for 2ch model only)
Coupling		AC, DC, LFrej, HFrej, Noise rej
Sensitivity		DC~25MHz: Approx. 0.5div or 5mV

		25MHz~max: Approx. 1div or 10mV
Ext Trigger (for 2ch model only)	Range	±15V
	Sensitivity	DC~30MHz: ~50mV 30MHz~max: ~100mV
	Input Impedance	1MΩ±2%, ~16pF
	Maximum Input	300V (DC + AC peak), CATII
Horizontal	Range	±15V
	Modes	Main, Window, Window Zoom, Roll, X-Y
	Accuracy	±0.01%
	Pre-Trigger	20 div maximum
	Post-Trigger	1000 div
X-Y Mode	X-Axis Input	Channel 1
	Y-Axis Input	Channel 2
	Phase Shift	±3 at 100kHz
Signal Acquisition	Real-Time	1G Sa/s maximum
	Equivalent	25G Sa/s maximum
	Vertical	8 bits
	Resolution	
	Record Length	25K Dots Maximum
	Single Shot	100MHz
	Bandwidth	
	Acquisition Mode	Sample, Peak Detect, Average, Accumulate
	Peak Detection	10ns
Average	2, 4, 8, 16, 32, 64, 128, 256	
Cursors and Measurement	Voltage	Vpp, Vamp, Vavg, Vrms, Vhi, Vlo, Vmax, Vmin, Rise Preshoot/ Overshoot, Fall Preshoot/ Overshoot
	Time	Freq, Period, Rise Time, Fall Time, Positive Width, Negative Width, Duty Cycle
	Delay	FRR, FRF, FFR, FFF, LRR, LRF, LFR, LFF
	Cursors	Voltage difference (ΔV) Time difference (ΔT)
	Auto Counter	Resolution: 6 digits

		Accuracy: $\pm 2\%$ Signal source: All available trigger source except the Video trigger
Control Panel Function	Auto Set	Automatically adjust vertical Volt/div, Horizontal Time/div, and Trigger level
	Save Setup	Internal memory: 20 sets USB Flash drive: unlimited
	Save Waveform + Template	Internal memory: 20 sets USB Flash drive: unlimited
Display	LCD	5.6 inch, TFT, brightness adjustable
	Resolution (dots)	234 (Vertical) x 320 (Horizontal)
	Graticule	8 x 10 divisions (menu On) 8 x 12 divisions (menu Off)
Interface	Go-No Go Output	Open collector
	RS-232C	DTE DB 9-pin male
	GPIB (Optional)	IEEE488.2 24-pin female
	USB	Host: Flash drive, Printer Device: Remote control
Power Source	Line Voltage	100V~240V AC, 48Hz~63Hz
	Battery (Optional)	10.8V Li-Ion pack, 6600mAh per pack 12hour charge time (from AC line) 3 hour operating time (depend on conditions)
Miscellaneous	Language Selection	English, Chinese (Traditional), Chinese (Simplified), Russian
	On-Line Help	
	Real-Time Clock	Display: yy/mm/dd/hh/ss (time stamp for saved data)
Dimensions	254D x 142H x 310W (mm)	
Weight	Approx. 4.3kg	
Temperature	Operating	0°C~50°C
	Storage	-20°C~70°C
Humidity	Operating	80% R.H. @35°C
	Storage	80% R.H. @70°C

Declaration of Conformity

We
 GOOD WILL INSTRUMENT CO., LTD.
No. 95-11, Pao-Chung Rd., Hsin-Tien City, Taipei Hsien, Taiwan
GOOD WILL INSTRUMENT (SUZHOU) CO., LTD.
No. 69, Lushan Road, Suzhou New District Jiangsu, China
declare that the below mentioned product
 GDS-2000
is herewith confirmed to comply with the requirements set out in the Council Directive on the Approximation of the Law of Member States relating to Electromagnetic Compatibility (89/336/EEC, 92/31/EEC, 93/68/EEC) and Low Voltage Equipment Directive (73/23/EEC, 93/68/EEC). For the evaluation regarding the Electromagnetic Compatibility and Low Voltage Equipment Directive, the following standards were applied:

© EMC

EN 61326-1: Electrical equipment for measurement, control and laboratory use — EMC requirements (1997+A1: 1998+A2: 2001)	
Conducted and Radiated Emissions EN 55011: 1998 class A	Electrostatic Discharge EN 61000-4-2: 1995+A1:1998
Current Harmonic EN 61000-3-2: 2000	Radiated Immunity EN 61000-4-3: 1996+A1:1998
Voltage Fluctuation EN 61000-3-3: 1995	Electrical Fast Transients EN 61000-4-4: 1995
-----	Surge Immunity EN 61000-4-5: 1995
-----	Conducted Susceptibility EN 61000-4-6: 1996
-----	Power Frequency Magnetic Field EN 61000-4-8 : 1993
-----	Voltage Dips/ Interrupts EN 61000-4-11: 1994

© Safety

Low Voltage Equipment Directive 73/23/EEC & amended by 93/68/EEC
Safety Requirements
IEC/EN 61010-1: 2001

Index

- A**
- acquisition 41
 - Auto set
 - configuration 65
 - FAQ..... 117
 - functionality check 16
 - automatic measurement
 - configuration 66
 - view result..... 69
- B**
- battery
 - FAQ..... 116, 117
 - maintenance..... 63
- C**
- Calibration 113
 - coupling
 - channel 56
 - trigger..... 78
 - cursor
 - horizontal 45
 - vertical..... 47
- D**
- display
 - contents description 23
 - contrast 51
 - FAQ..... 116
 - grid 52
 - power-up sequence 14
- E**
- EN 61010..... 7, 8, 122
 - EN55011 122
 - EN61000 122
 - EXT input
 - description 18
 - trigger 83
- F**
- FAQ 116
 - fft operation 75
 - frequency limit..... 58
 - front panel 18
 - functionality check 15
 - fuse
 - safety instruction 7
 - specification..... 121
- G**
- GDS-2000
 - cleaning..... 5, 7
 - feature list 12
 - specifications 119
 - go-no go
 - edit 70
 - run..... 73
 - GPIB
 - IEEE remote interface..... 101
- H**
- help, built-in 59
 - horizontal
 - cursor 45
 - roll 54
 - xy mode..... 55
 - zoom in..... 54
- I**
- IEEE remote

commands.....	104	program and play	
interface.....	101	edit.....	76
syntax	103	run	77
image			
printout.....	86, 98		
save	88, 89		
		R	
		rear panel	21
		recall	
		default setting	95
		default setup.....	38
		setup.....	93
		waveform.....	93
		RS232	
		IEEE remote interface	101
		S	
		safety	
		guidelines.....	6
		symbol	6
		UK power cord	9
		save	
		image.....	88, 89
		setup.....	88, 89
		to memory	89
		to USB.....	88, 89
		waveform.....	88, 89
		setup	
		default	38
		recall.....	93
		recall default.....	95
		save	88, 89
		shortcut	
		key operation	26
		menu	29
		sound configuration	59
		specification	
		FAQ	117
		list.....	119
		storage environment	
		safety instruction	5, 8
commands.....	104		
interface.....	101		
syntax	103		
image			
printout.....	86, 98		
save	88, 89		
		M	
math operation	74		
memory length			
configure	43		
list	44		
menu on/off	53		
		O	
operation environment			
safety instruction	5, 8		
specification.....	121		
		P	
package contents	13		
PC software			
display	98		
download	97		
install.....	97		
interface.....	96		
operation.....	98		
power supply			
safety instruction	7		
power up sequence	14		
FAQ.....	116		
printout			
directly.....	86		
via PC	87, 98		
probe			
attenuation.....	58		
compensation	114		
FAQ.....	116		
functionality check.....	15		
package contents.....	13		

specification	121	FAQ	117
system information	60	save file	88, 89
T		software interface	96
V			
table of contents	3	vertical	
time		coupling.....	56
date setting	61	cursor	47
FAQ.....	117	W	
time setting	62	waveform	
trigger		accumulation	50
delay, event	83	freeze.....	51
edge.....	78	invert.....	57
pulse width.....	81	recall	93
video	80	save	88, 89
U		vector/ dot	49
USB			
configure files.....	91		